











# ONRK193C

**gorenje**  
Life Simplified

## Freestanding fridge freezer



-  IonAir with MultiFlow 360°
-  NoFrost Plus
-  ZeroZone drawer
-  A+++
-  AdaptTech
-  SuperCool
-  SimpleSlide shelves
-  XtremeFreeze drawer
-  LedLight
-  FastFreeze

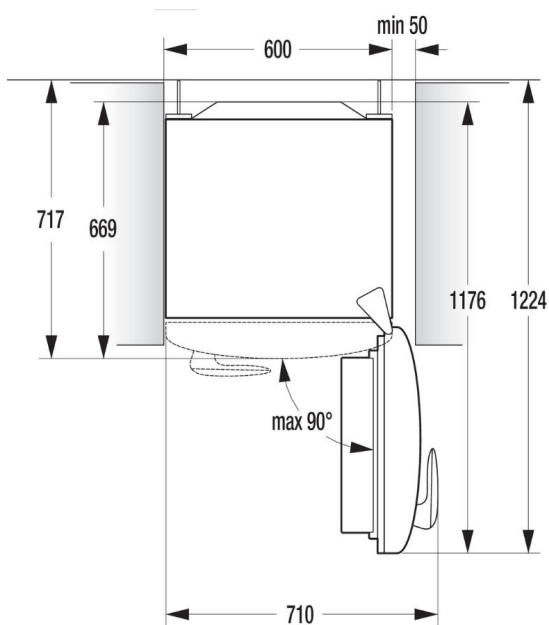

Energy class: **A+++**

Dimensions (W×H×D): **60 × 194 × 66.9 cm**

Door material: **Plastic**

Colour: **Champagne**

Door opening: **Right door opening**

Slot-in: possibility to put the appliance into the kitchen niche 65 cm

Climate class: **SN, N, ST, T**

Inverter compressor

Total gross/net volume: **334 / 307 l**

Capacity of cooling compartment: gross/net: **231 / 222 l**

Capacity of freezer compartment: gross/net: **103 / 85 l**

Freezing capacity in 24 hours: **8 kg / 24h**

Power cut safe time: **18 h**

Type of display: **LED display**

Sound alarm for open door

Temperature indicator: **Digital temperature indicator for freezer and refrigerator**

Sound and visual signal for high temperature in refrigerator: white signal

NoFrost Plus

IonAir with MultiFlow 360°

CrispZone with HumidityControl

AdaptTech: Adaptive Intelligent System

FastFreeze

SuperCool

Saving programme EcoMode

Decorative top

LED strip on the ceiling

4 glass shelves

The wire bottle rack

Door bottle container: **1 single container with fixed stopper**

Trays in refrigerator door: **2 SimpleSlide height adjustable door trays, 1 upper adjustable tray**

Number of cheese and butter storage: **1 MultiBox container**

ZeroZone drawer

XXL SpaceBox drawer

XtremeFreeze: very intensive freezing in the upper freezer drawer

Freezing compartment: **3 drawers**

2 glass shelves

Energy consumption kWh/24h: **0.46 kWh**

Noise level: **38 dB(A)re 1 pW**

Dimensions (W×H×D): **60 × 194 × 66.9 cm**

Dimensions of packed product (W×H×D): **64 × 200 × 77 cm**

Net weight: **70.5 kg**

Gross weight: **74.5 kg**

Connected load: **120 W**

Nominal current of fuse: **10 amp**

Product code: **521706**

EAN code: **3838942087974**



<https://eg.gorenje.com/en/product/521706>