

GB

IE

MT

**DETAILED
INSTRUCTIONS**
FOR USE OF GLASS
CERAMIC BUILT-IN
INDUCTION COOKING
HOB

gorenje

We thank you for your trust and the purchase of our appliance.

This detailed instruction manual is supplied to make the use of this product easier. The instructions should allow you to learn about your new appliance as quickly as possible.

Make sure you have received an undamaged appliance. If you do find transport damage, please contact the seller from which you purchased the appliance, or the regional warehouse from which it was supplied. The telephone number can be found on the invoice or on the delivery note.

Instructions for use are also available at our website:

www.gorenje.com / < <http://www.gorenje.com> />



Important information



Tip, note

CONTENTS

4 IMPORTANT SAFETY INSTRUCTIONS	INTRODUCTION
7 BUILT-IN GLASS CERAMIC INDUCTION COOKING HOB	
8 Technical specifications	
9 BEFORE USING THE APPLIANCE FOR THE FIRST TIME	PREPARING THE APPLIANCE FOR THE FIRST USE
10 INDUCTION COOKING SURFACE	COOKING HOB OPERATION
10 Glass ceramic cooking surface	
11 Power saving tips	
11 Pan recognition	
12 Induction cooking zone operating principle	
13 Induction cookware	
14 OPERATING THE COOKING HOB	
14 Control unit (depending on the model)	
15 Switching on the hob	
15 Switching on the cooking zones	
16 Automatic rapid heating	
17 Bridged cooking zone (depending on the model)	
19 Power zone with the power boost option	
20 Child lock/lock	
21 Defrosting/reheating	
22 Timer functions	
23 Pausing the cooking process with stop & go	
23 Overheat protection	
24 Memory function	
25 Switching off a cooking zone	
25 Residual heat indicator	
26 Switching off the entire cooking hob	
26 Automatic switch off	
26 Maximum cooking time	
27 User settings	
29 MAINTENANCE & CLEANING	MAINTENANCE & CLEANING
31 TROUBLESHOOTING TABLE	TROUBLE-SHOOTING
33 INSTALLING A BUILT-IN HOB	MISCELLANEOUS
43 CONNECTING THE COOKING HOB TO THE POWER MAINS	
45 DISPOSAL	

IMPORTANT SAFETY INSTRUCTIONS



CAREFULLY READ THE INSTRUCTIONS AND SAVE THEM FOR FUTURE REFERENCE.

This appliance can be used by children aged from 8 years and above and persons with reduced physical, sensory or mental capabilities or lack of experience and knowledge if they have been given supervision or instruction concerning use of the appliance in a safe way and understand the hazards involved. Children shall not play with the appliance. Cleaning and user maintenance shall not be made by children without supervision.

This appliance is not intended for use by persons (including children) with reduced physical, sensory or mental capabilities, or lack of experience and knowledge, unless they have been given supervision or instruction concerning use of the appliance by a person responsible for their safety.

Children should be supervised to ensure that they do not play with the appliance.

WARNING: The appliance and its accessible parts become hot during use. Care should be taken to avoid touching heating elements. Children less than 8 years of age shall be kept away unless continuously supervised.

WARNING: Accessible parts will become hot when in use. To avoid burns and scalds children should be kept away.

WARNING: Danger of fire: do not store items on the cooking surfaces.

CAUTION: The cooking process has to be supervised. A short term cooking process has to be supervised continuously.

WARNING: Unattended cooking on a hob with fat or oil can be dangerous and may result in fire. NEVER try to extinguish a fire with water, but switch off the appliance and then cover flame e.g. with a lid or a fire blanket.

WARNING: If the surface is cracked, switch off the appliance to avoid the possibility of electric shock. Switch off all cooking zones using their respective controls and remove the fuse or trip the main circuit breaker so that the appliance is fully isolated from the power mains.

Means for disconnection must be incorporated in the fixed wiring in accordance with the wiring rules.

Do not place objects like knives, forks, spoons, or lids on the induction cooking zone as they can become very hot.

Do not use steam cleaners or high pressure cleaners to clean the appliances as this may result in an electric shock.

The appliance is not intended to be controlled with external timers or special control systems.

WARNING: Use only hob guards designed by the manufacturer of the cooking appliance or indicated by the manufacturer of the appliance in the instructions for use as suitable or hob guards incorporated in the appliance. The use of inappropriate guards can cause accidents.

After use, switch off the hob element by its control and do not rely on the pan detector.

The appliance is intended for household use. Do not use it for any other purpose, e.g. for room heating.

The appliance may only be connected to the power mains by an authorised service technician or expert. Tampering with the appliance or non-professional repair thereof may result in risk of severe injury or damage to the product.

If another electrical appliance is connected to an AC power socket near the appliance, make sure the power cord does not come into contact with hot cooking zones.

If the **power cord** is damaged, it should be replaced by the manufacturer or an authorised service technician, in order to avoid hazard.

Using the glass ceramic hob as a storage area may result in scratches or other damage to it. Never heat food in aluminium foil or in plastic containers on the cooking hob. Such foil or containers may melt which can result in a fire or damage to the cooking hob.

Do not store temperature-sensitive items underneath the appliance, such as cleaners or detergents, spray cans etc.

Eventual mismatches in colour shades between different appliances or components within a single design line may occur due to various factors, such as different angles under which the appliances are observed, different coloured backgrounds, materials, and room illumination.



Carefully read the instructions for use before connecting the appliance. Repairs or any warranty claims resulting from incorrect connection or use of the appliance shall not be covered by the warranty.

BUILT-IN GLASS CERAMIC INDUCTION COOKING HOB

(DESCRIPTION OF EQUIPMENT AND FUNCTIONS - DEPENDING ON THE MODEL)

Since the appliances for which these instructions were drawn up may have different equipment, some functions or equipment may be described in the manual that may not be present in your appliances.

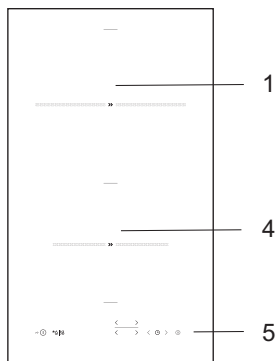
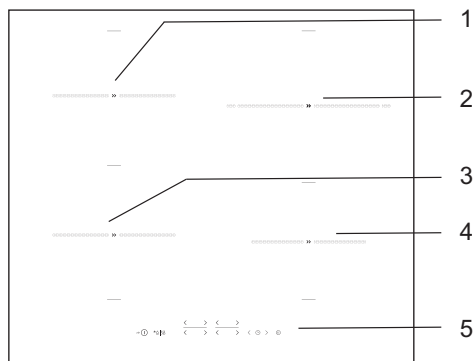

1. Induction cooking zone rear left
2. Induction cooking zone rear right
3. Induction cooking zone front left
4. Induction cooking zone front right
5. Cooking hob control module

TECHNICAL SPECIFICATIONS

(DEPENDING ON THE MODEL)

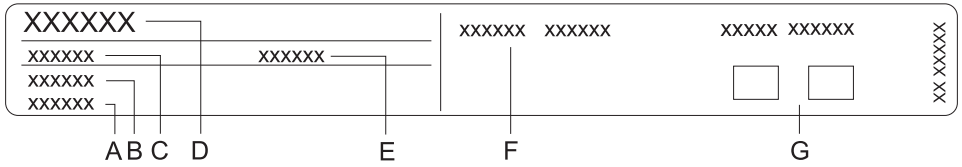

- A Serial number
- B Code/ID
- C Type
- D Brand
- E Model
- F Technical data
- G Compliance symbols

The rating plate with basic information on the appliance is located on the bottom side of the cooking hob.

Information on appliance type and model can be found on the warranty sheet.

BEFORE USING THE APPLIANCE FOR THE FIRST TIME

If your hob has a glass ceramic surface, clean it with a damp cloth and some washing-up liquid. Do not use aggressive cleaners, such as abrasive cleaners that could cause scratches, abrasive dishwashing sponges, or stain removers.

During initial use, characteristic "new appliance smell" may appear; it will gradually disappear.

INDUCTION COOKING SURFACE

GLASS CERAMIC COOKING SURFACE

- The hob is resistant to temperature changes.
- The hob is also impact-resistant.
- Using the glass ceramic hob as a storage area may result in scratches or other damage to it.
- Do not use the glass ceramic hob if it is cracked or broken. If a sharp object falls on the hob, the hob may break. The consequences of such occurrence may be visible immediately or only after a while. If any visible crack appears in the hob, immediately cut off the power supply to the appliance.
- Make sure the cooking zone and the cookware bottom is clean and dry. This will allow better conduction of heat and prevent any damage to the heating surface. Do not place empty cookware on the cooking zone.
- The cooking zone may be damaged if you place an empty pan onto it. Before placing a pan onto the cooking zone, wipe the pan bottom dry to allow conduction of heat.

COOKING POWER LEVELS

Cooking zone heat power can be set to ten different levels. The table lists some examples of use for each level.

Level	Purpose
0	Switched off, using the residual heat
1 - 2	Keeping the food warm, slow cooking of smaller amounts (lowest setting)
3	Slow cooking (follow-up cooking after the initial power boost)
4 - 5	Slow cooking (follow-up cooking) of large amounts, pan-roasting of larger chunks
6	Searing and browning
7 - 8	Searing
9	Cooking of large amounts, searing
P	Power boost setting for start of the cooking process; also suitable for very large amounts of food

POWER SAVING TIPS

- When purchasing cookware, note that the diameter indicated on the pan usually pertains to the upper edge or the lid, which is normally larger than the diameter of the pan bottom.
- If a dish takes a long time to cook, use a pressure cooker. Make sure there is always sufficient liquid in the pressure cooker. If an empty cooker is placed on the cooking hob, it may overheat which in turn may lead to damage to both the pot and the cooking zone.
- Whenever possible, close the pot or pan with a suitably sized lid. Use cookware that fits the amount of food you are cooking. Cooking in a large partly full pot will consume much more energy.

PAN RECOGNITION



- Even if there is no pot or pan on the cooking zone or if the pan used has a diameter that is smaller than the diameter of the cooking zone, there will be no losses of energy.

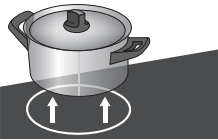

- "If the pan is much smaller than the cooking zone, there is a possibility that it will not be recognized by the cooking zone. When the cooking zone is activated, the sign  and the selected power level will flash alternately on the cooking power display.

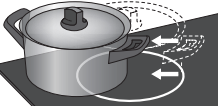

If a suitable pan is placed on the induction cooking zone within the next minute, the hob will recognize it and switch on with the selected cooking power. As soon as the pan is removed from the cooking zone, the power supply is cut off."

- If a smaller pan or pot is placed on the cooking zone and it is recognized, the hob will only use as much power as necessary given the pan size.

INDUCTION COOKING ZONE OPERATING PRINCIPLE

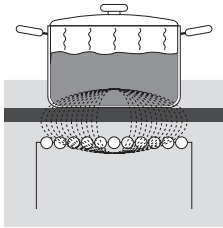

- The cooking hob is fitted with highly efficient induction cooking zones. The heat is generated directly in the bottom of the pan where it is needed the most. This avoids any losses through the glass ceramic surface. Power consumption is considerably lower than in conventional cooking zones with radiation heaters.
- The glass ceramic cooking zone is not heated directly, but only indirectly with the heat radiated back by the pan. After the cooking zone is switched off, this heat is indicated as »residual heat«.
- In induction cooking zones, heating is made possible by the induction coil installed under the glass ceramic surface. The coil induces a magnetic field which generates eddy currents in the bottom of a ferromagnetic pan, which in turn heats the pan.



If sugar or food with high sugar content is spilled over a hot glass ceramic hob, immediately wipe the hob or remove the sugar with a scraper, even if the cooking zone is still hot. This will prevent any damage to the glass ceramic surface.

Do not use detergents and other cleaners to clean a hot glass ceramic hob as this could damage the surface.

INDUCTION COOKWARE

COOKWARE SUITABLE FOR AN INDUCTION HOB

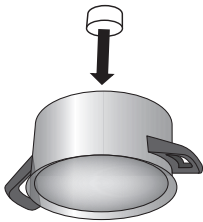

- The induction will work correctly if you use suitable cookware.
 - Make sure the pot or pan is in the middle of the cooking zone.
 - Suitable cookware: cookware made of steel, enamel-coated steel pans, or cast iron pans.
 - Unsuitable cookware: alloy steel cookware with copper or aluminium bottom, and glass cookware.
 - The magnet test: Use a small magnet to check whether the pan or pot bottom is ferromagnetic. If the magnet sticks to the bottom of the pan, then it is suitable for an induction cooker.
-
- When using a pressure cooker, keep an eye on it until the right pressure is reached. First, set the cooking zone to maximum power; then, following the pressure cooker manufacturer's instructions, decrease the cooking power when appropriate.
 - Make sure there is enough liquid in the pressure cooker or any other pot or pan. Due to overheating, using an empty pot on the cooking zone may result in damage to both the pot and the cooking zone.
 - Some cookware does not have a fully ferromagnetic bottom. In such case, only the magnetic part will heat up, while the rest of the bottom will remain cool.
 - When using special cookware, observe the manufacturer's instructions.
 - For best cooking results, the ferromagnetic area on the cookware bottom should match the size of the cooking zone. If the cooking zone does not recognize the pan, try placing it on a different cooking zone with a smaller diameter.

Cooking zone	Minimum pan bottom diameter
Ø 160 mm	Ø 90 mm
Ø 180 mm	Ø 90 mm
Ø 210 mm	Ø 110 mm
190 x 210 mm	Ø 110 mm
Bridge (octa)	Ø 230 mm

Pan bottom has to be flat.

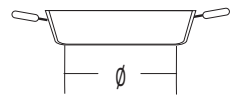
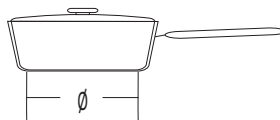
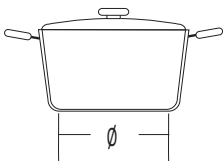

OPERATING THE COOKING HOB

CONTROL UNIT (depending on the model)

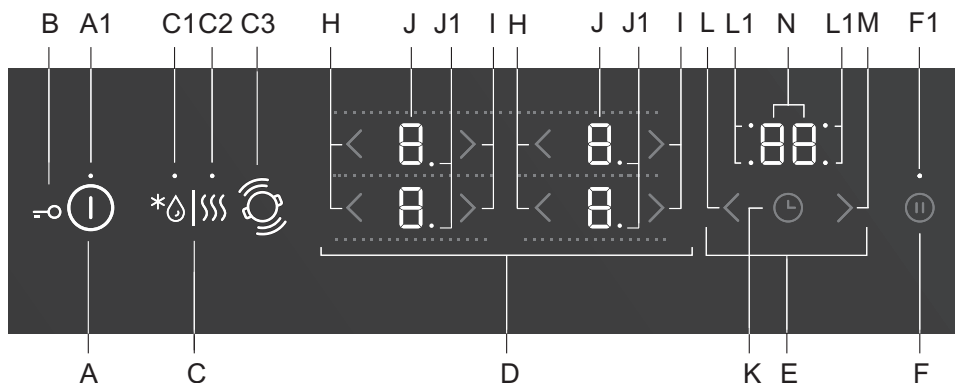

Settings sensor keys:

- A Hob on/off key
- A1 On/off/child lock indicator light
- B Lock/child lock key
- C Defrosting/reheating key
- C1 Defrosting indicator light
- C2 Reheating indicator light
- C3 Pan position recognition with automatic bridging of cooking zones
- D Cooking zone controls
- E Timer functions
- F Stop/go/memory function
- F1 Stop/go and memory function indicator light
- H Power decrease key
- I Power increase key
- J Power level displays
- J1 Decimal point indicating half-step power level for the cooking zone
- K Program timer on/off
- L Program timer setting key (-)
- L1 Indicator light for active program timer for respective cooking zones
- M Program timer setting key (+)
- N Time display

SWITCHING ON THE HOB

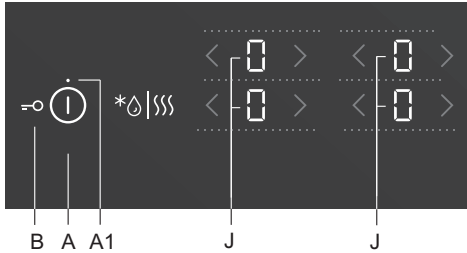

Place the cookware onto the cooking hob. Touch the on/off key (A) to switch on the hob. "0" will appear on all cooking zone displays. A brief acoustic signal will be emitted and an indicator light will light up above the (A1) key.



If no cooking zone is switched on in 10 seconds, the cooking hob will power off.

SWITCHING ON THE COOKING ZONES

There are a total of either 9 or 17 different power levels that can be selected. In case of 17 power levels, the dot on the display indicates a half step (e.g. 8. means 8.5, depending on the model).

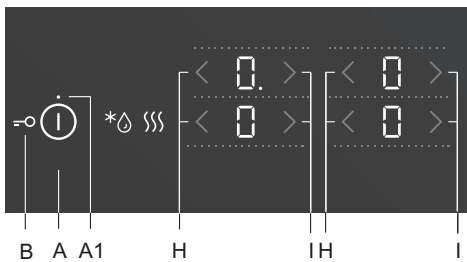

After the hob is switched on (in the next 10 seconds), switch on the desired cooking zone. Use the (H) and (I) keys to select the desired setting for the activated cooking zone. If you first touch the (I) key, the power level will be set to "9". If you first touch the (H) key, the power level will be set to "4".

Changing the cooking zone settings

Power level can be changed at any time by touching the relevant (H) or (I) key.

To increase or decrease the power level faster, touch and hold the (H) or (I) key.

AUTOMATIC RAPID HEATING

All cooking zones are fitted with a special mechanism that sets the cooking power to maximum at the start of the cooking process, regardless of the actual power setting. Automatic rapid heating function temporarily increases the operating power to quickly heat up the pan bottom (9). After a while, the cooking zone power switches back to the initially set level (1 to 8).

The auto rapid heating function is suitable for dishes that have to be heated up at maximum power first, and then cooked for a longer period of time.

The auto rapid heating function is not suitable for braising, frying or sautéing, food that requires frequent turning, basting, or mixing, or food that has to boil for a longer period of time in a pressure cooker.

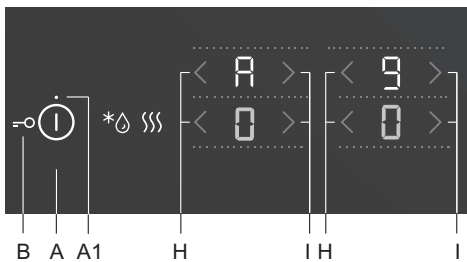

The hob is switched on and a suitable pan is placed on one of the cooking zones. The cooking zone should be off; "0" should appear on the display unit. Press the relevant (I) key and hold it for approximately 3 seconds until you hear a short beep.

"A" and "9" will flash alternately on the display.

Decrease the power to the level you wish to cook with after the automatic rapid heating.

"A" and selected power level will alternate on the power level display. When the automatic rapid heating time expires, the cooking zone automatically switches to the selected level that will then be continuously displayed.

AUTOMATIC RAPID HEATING TABLE

Power level	1	1.	2	2.	3	3.	4	4.	5	5.	6	6.	7	7.	8	8.
Automatic rapid heating time (sec)	40	60	70	100	120	150	180	220	260	300	430	400	120	150	195	200

SWITCHING OFF THE AUTOMATIC RAPID HEATING

If cooking power is decreased while the automatic rapid heating is activated, then automatic rapid heating for this cooking zone will be switched off.

The automatic rapid heating is also switched off if you switch off the selected cooking zone by simultaneously pressing the (H) and (I) keys.

BRIDGED COOKING ZONE (depending on the model)

- Some models allow combining two cooking zones into a single large connected cooking zone. Thus, a large oval pan or a griddle can be placed on the combined cooking field. The pan has to be large enough to cover the centres of the upper and lower cooking zone.
- Maximum pan size: 40 x 25 cm. For even heat distribution, we recommend using a heavy-bottom baking dish or pan. During cooking, the dish or pan will heat up. Be careful to prevent burns.
- When placing the baking dish on the hob, make sure it does not cover the control module.

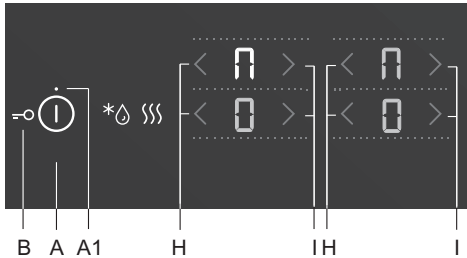

Activating the bridged cooking zone

- Switch on the cooking hob by pressing the on/off sensor (A).
- Simultaneously touch the two sensors and hold them for 3 seconds (H). The sign  will appear on the display unit for the rear field to indicate that the two cooking zones are bridged.
- Set the desired cooking power for the bridged cooking zone.
- To change the bridged zone's cooking power later on, use the (H) or (I) key for the lower cooking zone.
Note: The bridged zone does not allow the power boost setting P. Maximum available power level is 9.«

Deactivating the bridged cooking zone

- Reduce the power of the bridged zone to 0. The bridged zone symbol  will disappear and heating will be switched off.
- Both cooking zones will operate independently.



PAN POSITION RECOGNITION WITH AUTOMATIC BRIDGING OF COOKING ZONES (Only with some models.)

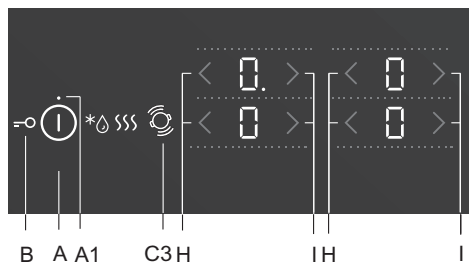

Pan position recognition is activated automatically 10 seconds after the appliance is switched on.

If there is a pan on the hob, the pan recognition function will recognize its position and automatically bridge the cooking zones depending on the size of the pan. Two adjacent cooking zones can be merged into a single large cooking zone.

The sign  will appear on the display unit for the rear field to indicate that the two cooking zones are bridged.

- Set the desired cooking power for the bridged cooking zone.
- To change the bridged zone's cooking power later on, use the (H) or (I) key for the lower cooking zone.

Note: The bridged zone does not allow the power boost setting P. Maximum available power level is 9.

Automatic pan position recognition can be activated at any time for 10 seconds by pressing the pan recognition key (C3). Automatic pan recognition and automatic cooking zone bridging are only effective on the cooking zones that are not yet activated. The cooking zone bridge function can be switched off by setting the power level to "0".

If there is no pan on the cooking hob:

- Switch on the hob. All cooking zones are set to »0«.
- Place the pan on any cooking zone. »0« starts to flash on the cooking zone with the pan. Cooking zone power can be adjusted by pressing the (H) or (I) keys for the respective cooking zone. The function automatically bridges the cooking zones depending on the pan size.
- You may continue with the next pan, using the same procedure.

If the pan is already on the cooking hob:

- Switch on the cooking hob.
- »0« will flash on the display unit of the cooking zone with the pan on it. Cooking zone power can be adjusted by pressing the (H) or (I) keys for the respective cooking zone.
- If there are several pans on the cooking zone, the hob will automatically detect all pans and »0« will flash on display units of all zones on which a pan has been placed.

Cooking zone power can be adjusted by pressing the (H) or (I) keys for the respective cooking zone; then continue with the next cooking zone.

During the first 10 seconds, automatic pan recognition can also be deactivated in user settings using the Au parameter. See chapter "User Settings".

The function can be used if the pan is already on the cooking hob or if the cooking hob is empty.

POWER ZONE WITH THE POWER BOOST OPTION

In some models, a power boost can be activated on all cooking zones indicated with "P" or "»". Power boost is not active for all cooking zones simultaneously. This allows faster heating of both the cookware and the food.

The function allows temporary cooking at maximum power for up to 5 minutes. Then, the operating power is automatically reduced to level 9. The function can be reactivated if the system is not overheated.

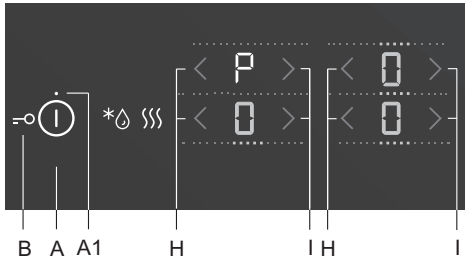

- The hob is switched on and a suitable pan is placed on one of the cooking zones.

Activating the power boost

- Select the cooking zone.
- Set the power level to 9, then press the (I) key. Symbol »P« will appear on the display. The function is activated.

Deactivating the power boost

- Press the (H) key. Power boost will be deactivated and operating power will return to level 9.
- Power can be decreased to desired level by pressing the (H) key.



The cooking zone with activated power boost (P) draws a lot of heating power. Therefore, the adjacent upper or lower cooking zone cannot be simultaneously set to maximum power; rather, its power will be limited to 9 for the duration of the power boost.

CHILD LOCK/LOCK

Child lock may be activated on the hob to prevent the appliance from being easily switched on.

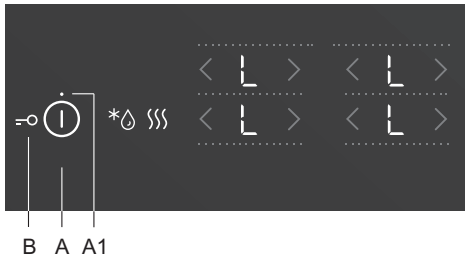

Locking the cooking hob controls

The hob must be switched off.
Touch the on/off key and hold it for 3 seconds. "L" will appear on the cooking zone power displays. The cooking hob is now locked. After 5 seconds, the cooking hob will automatically switch off to standby mode.

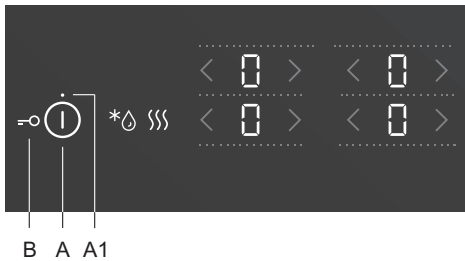

Unlocking the cooking hob controls

To unlock the cooking hob, proceed in the same way as for locking it. The hob must be switched off.
Touch the on/off key and hold it for 3 seconds. "L" on the cooking zone power indicators will turn to "O". The cooking hob is now unlocked and ready for use.

 If the child lock function is activated in the user settings mode (see chapter "User Settings"), then the hob will be automatically locked every time it is switched off.

 Activate the lock function before cleaning to prevent the hob from being inadvertently switched on.

DEFROSTING/REHEATING

Press the (C) key to activate the defrosting/reheating function. When defrosting, a temperature of 42 °C is maintained. At reheating, food temperature is maintained at 70 °C.

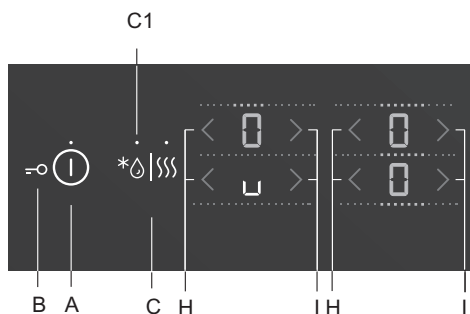

Activating the defrosting function

Press the (A) key to switch on the hob. Place a suitable pan on the selected cooking zone.

Touch the (C) key **once**; the indicator light (C1) will light up. Touch the (H) or (I) key for the selected cooking zone. The symbol "u" will appear on the display.

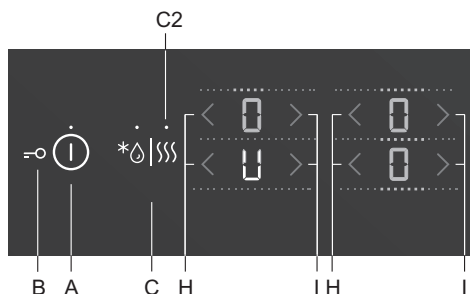

Activating the reheating function

Press the (A) key to switch on the hob. Place a suitable pan on the selected cooking zone.

Touch the (C) key **twice**; the indicator light (C2) will light up. Touch the (H) or (I) key for the selected cooking zone. The symbol "U" will appear on the display.

Switching off the defrosting/reheating function

- Touch the (H) or (I) key for the selected cooking zone.
- The cooking zone will switch off and »O« will appear on the display unit.

TIMER FUNCTIONS

Cooking time can be set from 1 to 99 minutes. This function allows two operating modes:



A MINUTE MINDER

Touch the timer/minute minder key (K) to activate the timer. "00" will appear on the timer display (O). Touch the (L) and (M) keys to set the time in the range from 1 to 99 minutes.

- After the set time expires, alarm will be activated; however, the cooking zone will not be switched off.
- Switch off the alarm by touching any key; alternatively, it will switch off automatically after a certain period of time.
- The minute minder function will remain activated even when the cooking hob is switched off using the (A) key.
- During the last minute of countdown, remaining time will be displayed in seconds.

B OFF TIMER FOR THE SELECTED COOKING ZONE

This function allows setting the cooking time for the selected cooking zone on which a power level has already been set. When the time expires, the cooking zone is switched off automatically.

Touch the timer/minute minder key (K) to activate the timer. »00« will appear on the timer display (O). Touch the (K) sensor key again. The point (L1) for the relevant cooking zone will start to flash.

- Touch the (L) and (M) keys to set the time in the range from 1 to 99 minutes.
- When the desired value is set, the countdown begins. The point (L1) indicating which cooking zone the timer function is set for will continue to flash.
- After the set time has expired, acoustic signal will be activated and the cooking zone will be switched off. »00« will flash on the clock display. Switch of the alarm by touching any key; alternatively, it will switch off automatically after a certain period of time.

Cooking time can be set separately for each cooking zone. If several timer functions are activated, the remaining times of respective cooking zones will alternate on the display unit in intervals lasting a few seconds. A flashing indicator light will indicate the relevant cooking zone.

Changing the cooking time

- Remaining cooking time can be changed at any time during cooking.
- Touch the power-off timer key (K) to select the timer display for the desired cooking zone. The relevant indicator light (L1) will flash.
- Touch the (L) or (M) key to set a new desired cooking time.

Displaying the remaining cooking time

If several timer settings are activated, remaining cooking time can be displayed by touching the (K) key.

Timer reset

- Select the desired timer display by pressing the (K) key (see section Changing the set cooking time). The set timer will be displayed and the indicator light for the relevant cooking zone will light up.
- Touch the (M) key to set the value to »00«, or press the (L) and (M) keys simultaneously to immediately reset the value to »00«.

PAUSING THE COOKING PROCESS WITH STOP & GO

The STOP & GO function allows you to pause (or suspend) the cooking process, but keep all your settings.

To pause the cooking process, touch the STOP & GO key (F). An indicator light (F1) will light up above the key. Settings on the displays will start to flash. All settings are frozen, and the cooking zone are not heated (the heaters are switched off).

All keys except on/off and STOP & GO are inactive.

To deactivate the STOP & GO function, touch the STOP & GO key again. Indicator light (F1) will switch off.

If the STOP & GO function is not switched off, the entire hob will automatically switch off after 10 minutes.

OVERHEAT PROTECTION

- The hob is fitted with a cooling fan that cools the electronic components during cooking. The fan may operate for a while even after the end of the cooking process.
- Induction cooking hob is also fitted with an overheating protector that protects the electronic components from damage. The protector operates at several levels. When the cooking zone temperature gets very high, the cooking power is automatically reduced.

If this does not suffice, the cooking zone power continues to decrease, or the safety mechanisms switches off the cooking zone completely. In such case, the display unit will read »«F2««. When the cooking hob is cooled down, its total power will be available again.«

MEMORY FUNCTION

The memory function allows restoring the most recently selected settings in 5 seconds after the hob is switched off. This is convenient when, for example, you accidentally press the on/off key and switch off the entire hob, or if the cooking hob is switched off automatically due to some spilt liquid.

After switching off with the on/off key, you have 5 seconds to switch the control panel back on, and further 5 seconds to press the STOP & GO key (F) to restore your settings. During these 5 seconds, the indicator light above the settings restore key will flash. All settings active before the hob was switched off will be restored.

SWITCHING OFF A COOKING ZONE

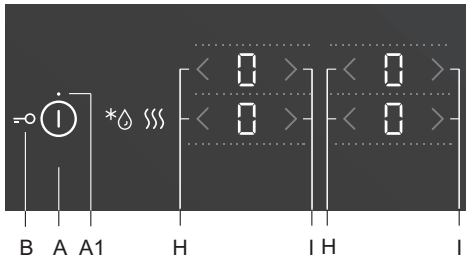

To switch off a cooking zone, use the relevant (H) key to set the value to "0". To quickly switch off the cooking zone, touch the relevant (H) and (I) keys simultaneously. You will hear a short beep, and "0" will be displayed on the display unit.

If the power of all cooking zones is set to "0", the cooking zone will switch off automatically after 10 seconds.

RESIDUAL HEAT INDICATOR

The glass ceramic hob is also fitted with a residual heat display, "H". The glass ceramic cooking zone is not heated directly, but only indirectly by the heat radiated back by the pan. As long as the symbol "H" is lit up after the hob has been switched off, there is residual heat in the cooking zone, which can be used to keep the food warm or for defrosting. When the "H" sign disappears, the cooking zone may still be hot. Be careful as there is danger of burns!

MAXIMUM COOKING TIME

For safety, the cooking time for each cooking zone is restricted to a maximum duration. Maximum cooking time depends on the most recently set power level. If the power level is not changed, the cooking zone will be switched off automatically after the maximum cooking duration is reached.

Power level	U	u	1	2	3	4	5	6	7	8	9	P*
Maximum operating time (hours)	2	8	8	8	6	6	4	4	2	1,5	1,5	1,5

*After 5 minutes, the power level automatically decreases to 9; after 1.5 hours, the cooking zone is switched off.

SWITCHING OFF THE ENTIRE COOKING HOB

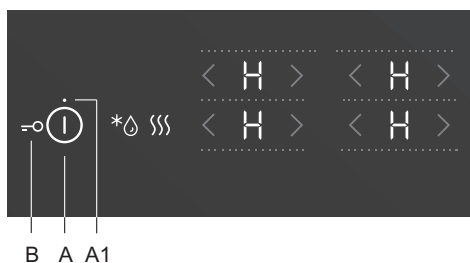

Touch the ON/OFF key (A) to switch off the entire hob. The hob will beep and all indicators will be switched off, except for the indicators for the cooking zones that are still hot, for which the residual heat indicator "H" will remain lit, warning that the cooking zone is still hot.

AUTOMATIC SWITCH OFF

If the keys are activated for too long during cooking (e.g. due to spilt liquid or an object placed over the sensor keys), all cooking zones will be switched off after 10 seconds, and the sign \perp will appear on the display unit.

The object should be removed, or the spilt liquid should be cleaned, from the sensor keys within 2 minutes; otherwise, the cooking hob will switch off automatically.

The most recent settings can be restored with the memory function using the STOP & GO key (F).

USER SETTINGS

SETTING THE ACOUSTIC SIGNAL AND LOCK PARAMETERS

You can adjust the volume of the acoustic signal, duration of acoustic alarm, total maximum appliance power, and automatic lock settings.

To activate the parameter settings menu, press the pause key (F) when the appliance is switched off, and hold it for 3 seconds.

The first parameter "Uo" will appear on the timer display, indicating the volume (loudness) of acoustic signals. Press the timer key (K) to select the type of parameter. Press the timer setting keys (L) and (M) to adjust the parameter.

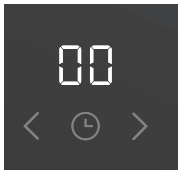

Uo - acoustic signal and alarm volume (loudness)

So - alarm duration

Lo - Automatic lock

Au: Automatic pan recognition

Po - Total maximum power



The currently set parameter value will appear on the right-hand side cooking zone power level displays. The value can be adjusted by pressing the (H) or (I) keys for the cooking zone.

All parameters can be confirmed and stored by pressing and holding the pause (F) key for 2 seconds. Then, a short beep will be heard. If you do not wish to store the new parameter settings, close the user settings mode by pressing the on/off key.

Acoustic signal and alarm volume (loudness) "Uo"

The following values can be set:

00 on the display = off (does not apply to alarm and error acoustic signal)

01 on the display = minimum volume

02 on the display = medium volume

03 on the display = maximum volume (default)

A short acoustic signal will be sounded upon every change, with the newly set volume.

Acoustic alarm duration "So"

The following values can be set:

05 on the display = 5 seconds

1,0 on the display = 1 minute

2,0 on the display = 2 minutes (default)

Child safety lock "Lo"

If the automatic lock function is activated in the user settings mode, the cooking hob will be automatically locked every time it is switched off.

00 on the display = off (default)

01 on the display = on

Pan position recognition with automatic cooking zone bridging »Au«

If the function of pan position recognition with automatic cooking zone bridging is deactivated in the user settings mode, then the appliance will always be operated manually (there will be no 10-second automatic pan recognition every time the appliance is switched on).

0 on the display = off

1 on the display = on (default)

Total maximum power »Po«

If the electric installation in your home has different current limits, maximum power consumption of the cooking hob can be reduced:

2.3 on the display unit = 2.3 kW = 10 A

2.8 on the display unit = 2.8 kW = 12 A

3.0 on the display unit = 3.0 kW = 13 A

3.7 on the display unit = 3.7 kW = 16 A

7.4 on the display unit = 7.4 kW = 2 x 16 A (preset)



If the power level is limited, the settings and the resulting cooking power can be limited as well. The appliance is fitted with a power management system that makes sure the effect of power limiting is minimal.

MAINTENANCE & CLEANING



Be sure to unplug the appliance from the power supply and wait for the appliance to cool down.

Children should not clean the appliance or perform maintenance tasks without proper supervision.

After each use, wait for the glass ceramic surface to cool down and clean it. Otherwise, all remaining impurities will burn onto the hot surface the next time you use the hob.

For regular maintenance of the glass ceramic hob, use special care products that create a protective film on the surface to prevent the dirt from sticking onto it.



Before each use of the glass ceramic surface, wipe off the dust or any other impurities that could scratch the surface, from both the hob and the pan bottom.



Steel wool, coarse cleaning sponges, and abrasive powders may scratch the surface. The surface may also be damaged by aggressive spray cleaners and unsuitable liquid cleaners.



Signage may be worn when using aggressive or abrasive cleaners or cookware with coarse or damaged bottom.

Use a damp soft cloth to remove **minor impurities**. Then, wipe the surface dry.

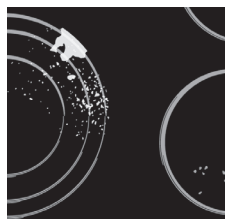

Remove **water stains** with a mild solution of vinegar. However, do not use this solution to wipe the frame (only with some models) as it may lose its sheen. Do not use aggressive spray cleaners or descaling agents.

Use special glass ceramic cleaners for **stubborn dirt**. Observe the manufacturer's instructions. **Be sure to thoroughly remove any cleaner residues after the cleaning process as they may damage the glass ceramic surface when the cooking zones heat up.**



Remove stubborn and burnt residues with a scraper. Be careful when handling the scraper to prevent injury.



Only use the scraper when dirt cannot be removed with a wet cloth or special cleaners for glass ceramic surfaces.



Hold the scraper at the **correct angle** (45° to 60°). **Gently press** the scraper against the glass and slide it over the signage to remove the dirt. Make sure the plastic handle of the scraper (in some models) does not come into contact with a hot cooking zone.



Do not press the scraper perpendicularly against the glass and do not scratch the hob surface with its tip or blade.

Immediately remove any **sugar or sugar-laden food** from the glass ceramic hob using a scraper, even if the hob is still hot, as sugar may permanently damage the glass ceramic surface.



Any changes to the sheen of the graphic design elements or discolouration should not be deemed as damage to the appliance, but rather a result of normal use of the cooking hob. Such discolouration is most commonly a result of food residues burnt onto the surface, or it may be caused by some cookware materials (such as aluminium or copper). Such discolouration is very difficult to remove entirely.

Note: Discolouration and similar flaws only affect the appearance of the hob and do not directly affect its function. Removing such flaws shall not be covered by the warranty.

TROUBLESHOOTING TABLE

NOISE AND ITS CAUSES DURING INDUCTION COOKING

Noises and sounds	Cause	Solution
Induction-generated operating noise	Induction technology is based on the properties of some metals under electromagnetic effect. It results in so-called eddy currents that force the molecules to oscillate. These oscillations (vibrations) are transformed into heat. Depending on the type of metal, this could result in quiet noises.	This is normal and it is not a result of any malfunction.
Transformer-like buzz	Occurs when cooking at a high power level. The reason for this is the amount of energy transferred from the cooking hob to the pot or pan.	This noise will disappear or weaken when you reduce the power level.
Vibration and crackling of the cookware	This noise appears in cookware (pots or pans) made of different materials.	It results from vibrations along the adjacent surfaces of different material layers. This noise depends on the cookware. It can vary depending on the amount and type of food being cooked.
Fan noise	Correct operation of induction electronic components requires temperature control. Therefore, the cooking hob is fitted with a fan which operates at varying speed, depending on the perceived temperature.	The fan may operate even after the cooking hob has been switched off, if the temperature remains too high.

SAFETY FUNCTIONS AND ERROR DISPLAY

The cooking hob is fitted with overheating sensors. These sensors can automatically switch off any cooking zone or the entire hob temporarily.

Error, possible cause, solution

- Continuous beep and  flashing on the display.
 - Water spilt over sensor surface, or an object placed over the sensors.
Wipe the sensor surface.
- «F2» on the display
 - Cooking zone has overheated. Wait for the cooking zone to cool down.
- »F« on the display
 - This indicates that there has been an error during operation.



If an error occurs or if the error indicator "F" does not disappear, disconnect the cooking hob from the power mains for a few minutes (undo the fuse or switch off the main switch); then, reconnect the hob to the power mains and switch on the main switch key.

If the problems persist despite observing the advice above, call an authorised service technician. Repair or any warranty claim resulting from incorrect connection or use of the appliance shall not be covered by the warranty. In this case, the user will cover the cost of repair.



Before the repair, disconnect the appliance from the power mains (by removing the fuse or by removing the plug from the wall outlet).

INSTALLING A BUILT-IN HOB

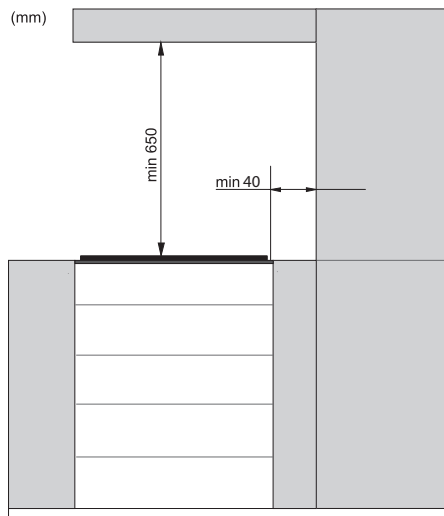

- Use of solid wood corner trims on worktops behind the cooking zone is only allowed if the clearance between the trim and the cooking hob is no smaller than indicated on the installation plans.

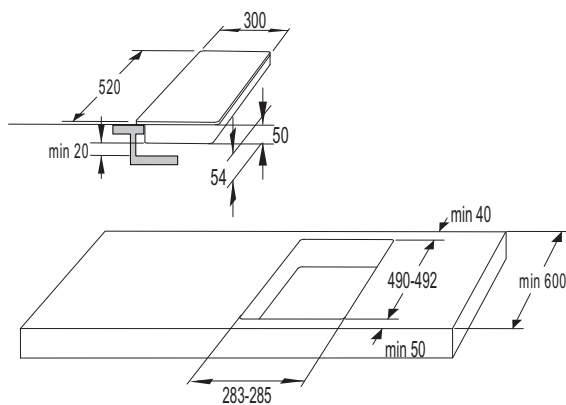

30cm

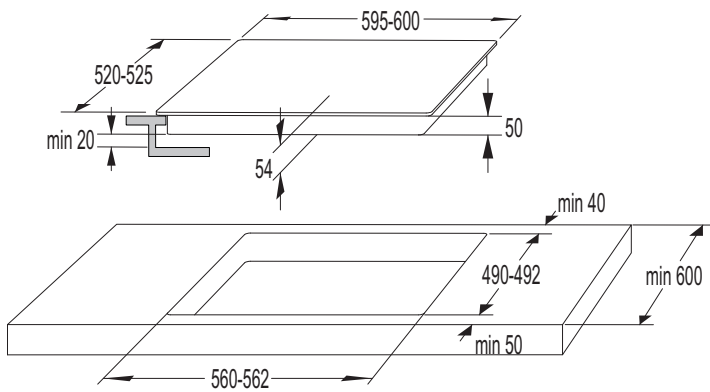

60cm

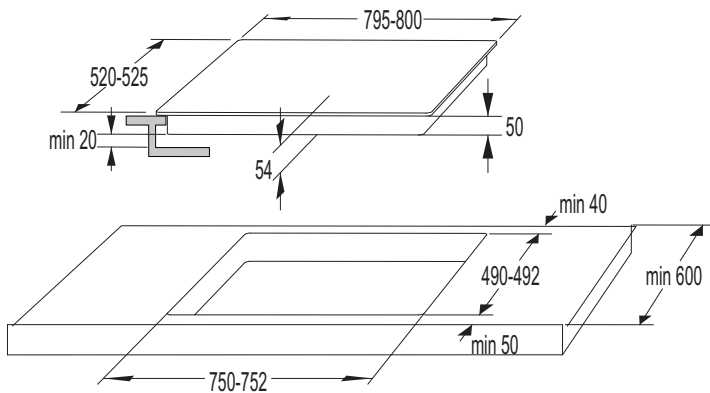

80cm

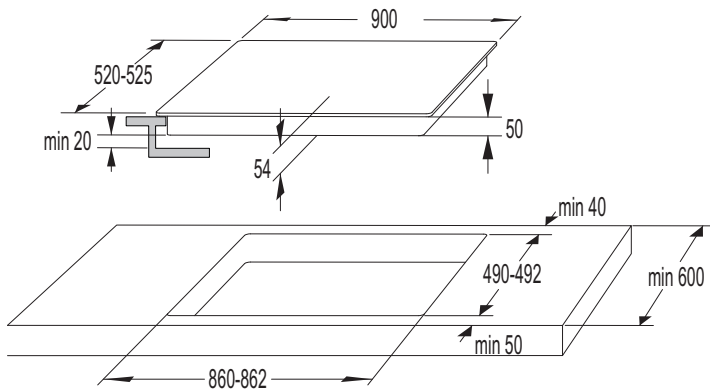

90cm

AIR VENTS IN THE LOWER KITCHEN CABINET

- Normal operation of the induction cooking hob electronic components requires sufficient air circulation.

A Lower cabinet with a drawer

- There must be an opening with a height of no less than 140 mm along the entire width of the cabinet in the cabinet rear wall. In addition, there should be an opening of at least 6 mm in the front side, along the entire width of the cupboard.
- A horizontal partition panel should be installed underneath the cooking hob along its entire length. There should be at least 20 mm of clearance between the lower end of the appliance and the partition panel.

Adequate ventilation should be allowed from the rear side.

- The hob is fitted with a fan located in its lower part. If there is a drawer below the kitchen cabinet, do not use it to store small objects or paper as these could, if sucked into the fan, damage the fan and the cooling system. Moreover, do not use the drawer to store aluminium foil or flammable substances or liquids (such as sprays). Keep such substances away from the cooking hob. Danger of explosion! There should be at least 20 mm of clearance between the contents of the drawer and the fan inlet vents.

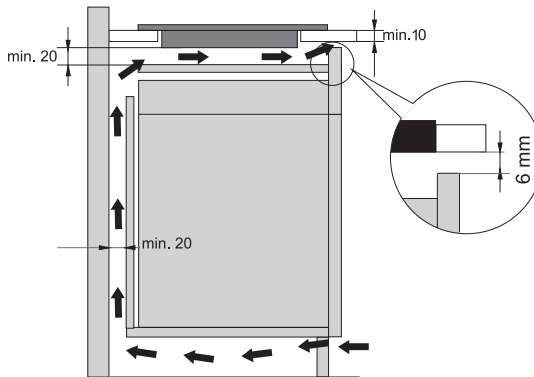

B Lower cabinet with an oven

- Installing an oven under the induction hob is possible for oven types EVP4.., EVP2.., EVP3.. with a cooling fan. Before installing the oven, the kitchen cabinet rear wall has to be removed in the area of the opening for installation. In addition, there should be an opening of at least 6 mm in the front side, along the entire width of the cabinet.
- If other appliances are installed under the induction cooking hob, we cannot guarantee their correct operation.

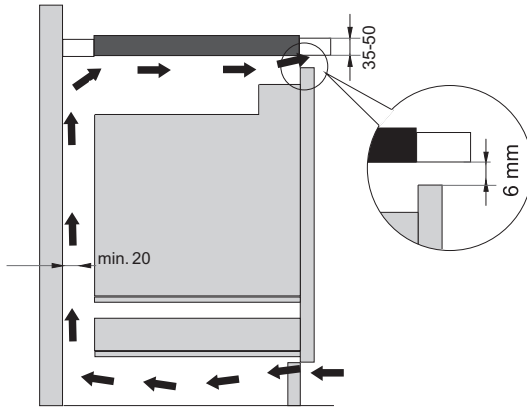

FLUSH-MOUNT INSTALLATION INTO THE WORKTOP

Appliances without faceted edges or decorative frames are suitable for flush mounting.

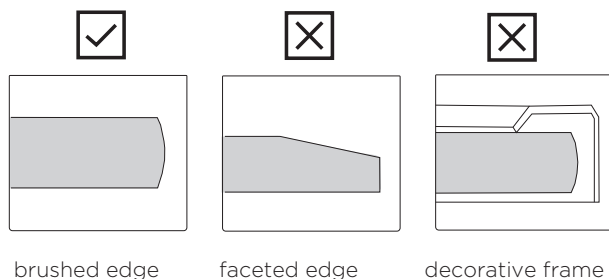

1. Installing the appliance

The appliance may only be installed into a temperature- and water-resistant countertop, such as a countertop made of (natural) stone (marble, granite), or solid wood (the edges along the cut-out have to be sealed). When installing into a countertop made of ceramics, wood, or glass, a wooden sub-frame should be used. The frame is not supplied with the appliance.

The appliance may only be installed into a countertop made of other materials after you have consulted the countertop manufacturer and obtained his express approval. Internal dimension of the basic unit should be at least equal to the internal cutout for the appliance. This will allow simple removal of the appliance from the countertop. Attach sealing tape along the perimeter of the bottom of the glass panel.

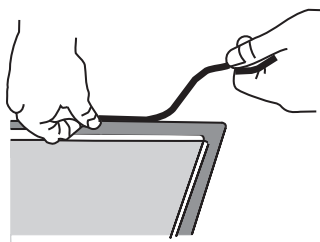

First, feed the power cord through the cutout. Place the appliance over the centre of the cutout.

Connect the appliance to the power mains (see instructions for connecting the appliance). Before sealing the appliance, test its operation.

Seal the slot between the appliance and the countertop using a silicone sealant. The silicone sealant used to seal the appliance has to be temperature-resistant (to at least 160 °C). Smooth out the silicone sealant using a suitable tool.

Observe the instructions for use of the selected silicone sealant. Do not switch on the appliance until the silicone sealant has dried completely.

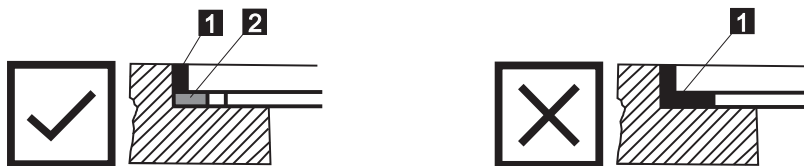

1. Silicone sealant, 2. Sealing tape



Pay particular attention to built-in dimensions with (natural) stone countertops. When choosing the silicone sealant, observe the countertop material and consult the countertop manufacturer. Use of inappropriate silicone sealants can result in permanent discolouration of some parts.

2. Removing the built-in appliance:

Disconnect the appliance from the power mains.

Use a suitable tool to remove the silicone gasket from the perimeter. Remove the appliance by pushing it upwards from the bottom side.



Do not attempt to remove the appliance from the upper side of the counter!



The service department shall only be responsible for repair and servicing of the cooking hob. Consult your specialized kitchen equipment dealer regarding the re-installation of the flush-mount cooking hob.

Stone countertop

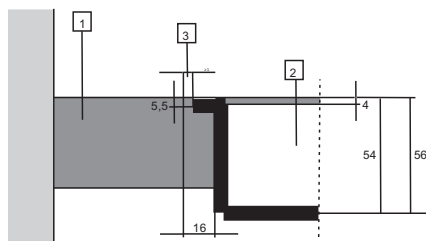

- 1 - Countertop
- 2 - Appliance
- 3 - Slot

Given the margin of error (tolerance) for the glass ceramic plate of the appliance, and the cutout in the countertop, the slot is adjustable (min. 2 mm).

Ceramic, wooden, or glass countertop

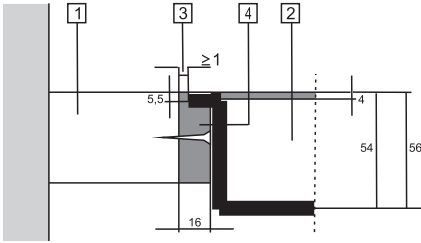

- 1 - Countertop
- 2 - Appliance
- 3 - Slot
- 4 - Wooden frame, thickness 16 mm.

Given the margin of error (tolerance) for the glass ceramic plate of the appliance, and the cut-out in the countertop, the slot is adjustable (min. 2mm). Install the wooden frame 5.5mm below the upper edge of the countertop (see figure).

Observe the radii of glass edges (R10, R2) when making the cut-out.

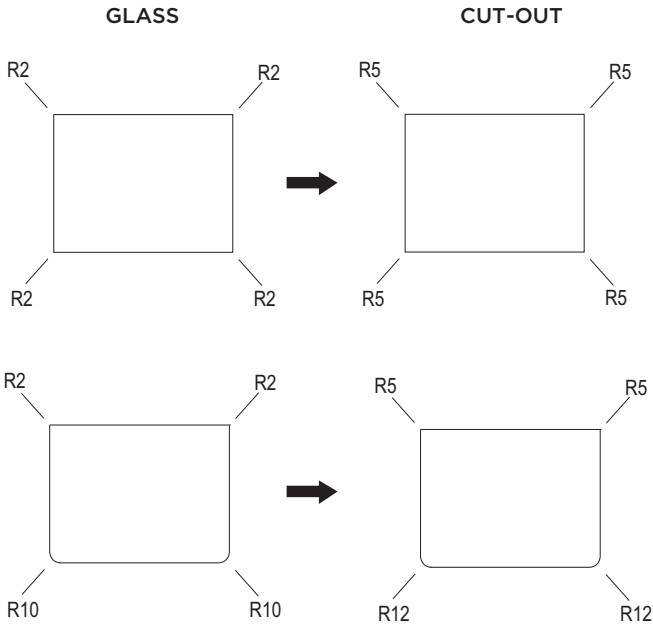

FLUSH-MOUNT INSTALLATION INTO THE WORKTOP - FLUSH MOUNT

(depending on the model)

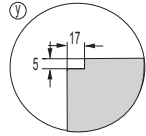
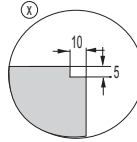
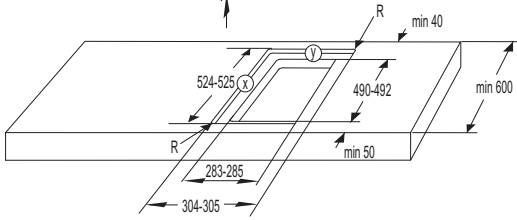
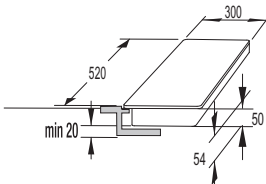

30cm

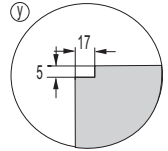
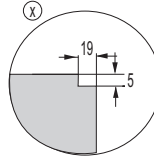
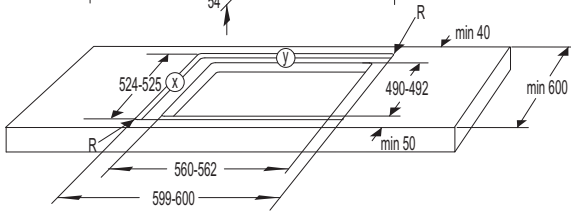
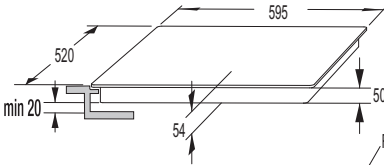

60cm

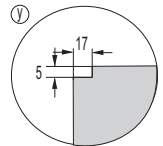
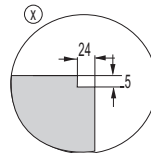
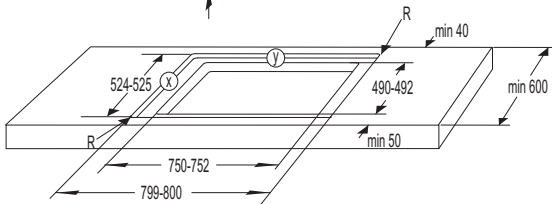
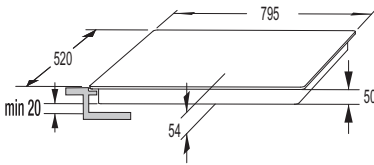

80cm

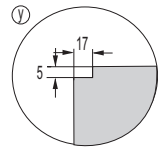
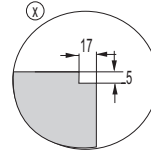
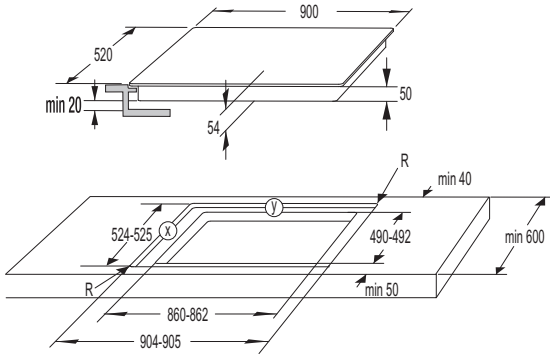

90 cm



If the oven is installed under a flush-mounted cooking hob, then the worktop thickness should be at least 40 mm.

FITTING THE FOAM GASKET



Some appliances come with the gasket already fitted!

Before installing the appliance into a kitchen worktop, attach the foam gasket supplied with the appliance to the bottom side of the glass ceramic hob.

- Remove the protective film from the gasket.
- Attach the gasket to the bottom side of the glass (2-3 mm away from the edge). The gasket has to be applied along the entire edge of the glass. The gasket may not overlap in the corners.
- When fitting the gasket, make sure it is not damaged by or in contact with any sharp objects.

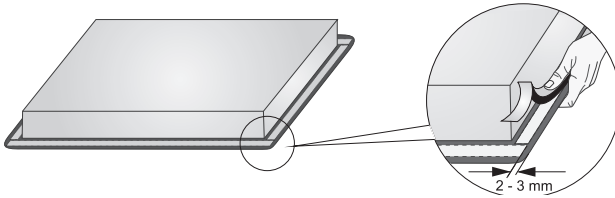

Do not install the appliance without this gasket!

- The worktop has to be completely level.
- Protect the cut out surfaces.

CONNECTING THE COOKING HOB TO THE POWER MAINS

- Power mains protection must conform to the relevant regulations.
- Before connecting the appliance, make sure the voltage indicated on the rating plate conforms to the voltage in your power mains.
- There should be a switching device in the electrical installation that can disconnect all poles of the appliance from the power mains, with a minimum clearance of 3 mm between the contacts when open. Suitable devices include fuses, protective switches etc.
- The connection should be adjusted to the current and fuses.
- After installation, the parts carrying electrical current and insulated parts shall be protected against contact.



The appliance may only be connected by an authorised expert. False connection can destroy parts of the appliance. In such case, there is no right to warranty. Disconnect the appliance from the power mains before any repair or maintenance operation.

CONNECTION DIAGRAM:

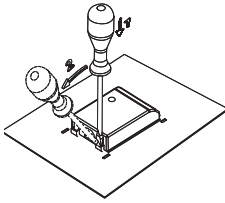

Jumpers (connecting bridges) are placed in the dedicated slot on the clamp.

POWER CORD

The following may be used for connection:

- PVC insulated connection cables type H05 VV-F or H05V2V2-F with yellow-and-green protective conductor, or other equivalent or superior cables.
- Exterior cable diameter should be at least 8.00 mm.

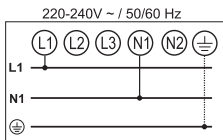
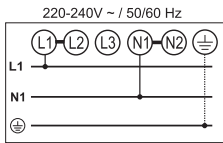
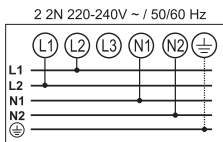
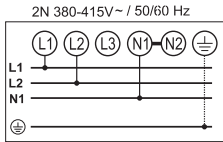

Normal connection

- 2 phases, 1 neutral conductor (2 1N, 380-415 V-/ 50/60 Hz):
 ▷ Voltage between phases and neutral conductor is 220-240 V-. Voltage between the two phases is 380-415 V-. Install a jumper between the terminals 4-5. The group should include at least two 16-ampere fuses. Diameter of the power cord core should be at least 2.5 mm².
- 2 phases, 2 neutral conductors (2 2N, 220-240V-/ 50/60 Hz):
 ▷ Voltage between phases and neutral conductors is 220-240 V-.
 ▷ The group (installation) should include at least two 16-ampere fuses. Diameter of the power cord core should be at least 2.5 mm².

Special connection:

- Single-phase connection (1 1N, 220-240 V-/ 50/60 Hz):
 ▷ Voltage between phase and neutral conductor is 220-240 V-. Install jumpers between the terminals 1-2 and 4-5. The group (installation) should be fitted with a fuse of at least 32 A. Power cord core diameter should be at least 4 mm².

Run the power cord through a cord strain relief (clamp) which protects the cable from being pulled out.

False connection can destroy parts of the appliance. In such case, there is no right to warranty.

Before connecting the appliance, make sure the voltage specified on the rating plate conforms to the voltage of the power mains. An expert should check the actual voltage in your home (220-240 V relative to N), using a suitable meter!

Appliances with a width of 30 centimetres (two cooking zones) only allow single-phase connection. The diameter of the power cord should be at least 1.5 mm²!

DISPOSAL



Packaging is made of environmentally friendly materials that can be recycled, disposed of, or destroyed without any hazard to the environment. To this end, packaging materials are labelled appropriately.

The **symbol** on the product or its packaging indicates that the product should not be treated as normal household waste. The product should be taken to an authorised collection centre for waste electric and electronic equipment processing.

Correct disposal of the product will help prevent any negative effects on the environment and health of people which could occur in case of incorrect product removal. For detailed information on removal and processing of the product, please contact the relevant municipal body in charge of waste management, your waste disposal service, or the store where you bought the product.

We reserve the right to any changes and errors in the instructions for use.

