

**gorenje**

EN

GB

IE

**INSTRUCTIONS FOR USE**  
COMBINED MICROWAVE  
OVENS

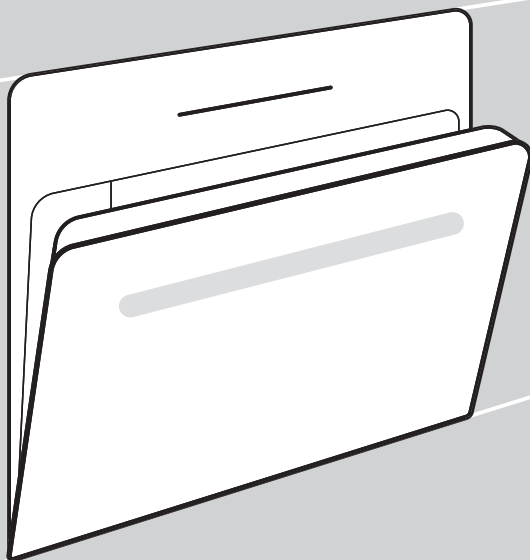

We thank you for your trust and the purchase of our appliance.

This detailed instruction manual is supplied to make the use of this product easier. The instructions should allow you to learn about your new appliance as quickly as possible.

Make sure you have received an undamaged appliance. If you do find transport damage, please contact the seller from which you purchased the appliance, or the regional warehouse from which it was supplied. The telephone number can be found on the invoice or on the delivery note.

Instructions for installation and connection are supplied on a separate sheet.

Instructions for use, installation and connection are also available at our website:

<http://www.gorenje.com>

The following symbols are used throughout the manual and they have the following meanings:



**INFORMATION!**

Information, advice, tip, or recommendation



**WARNING!**

Warning – general danger



It is important that you carefully read the instructions.

# Contents

<b>Safety precautions</b> .....	<b>4</b>
Safe use of the microwave oven .....	5
<b>Other important safety warnings</b> .....	<b>7</b>
<b>Appliance description</b> .....	<b>10</b>
Rating plate – product information .....	10
Control unit .....	11
<b>Appliance equipment</b> .....	<b>11</b>
Control lights .....	11
Guides .....	11
Oven door switch .....	12
Cooling fan .....	12
Oven equipment and accessories .....	12
<b>Before first use</b> .....	<b>14</b>
<b>Microwave function</b> .....	<b>14</b>
<b>Switching on for the first time</b> .....	<b>14</b>
<b>Choosing the settings</b> .....	<b>16</b>
PROFESSIONAL MODE (pro bake) .....	16
AUTOMATIC MODE (auto bake) .....	23
CHOOSING EXTRA FUNCTIONS (extra bake) .....	26
Child lock .....	26
<b>Starting the cooking process</b> .....	<b>28</b>
<b>End of cooking by touching</b> .....	<b>28</b>
<b>General settings</b> .....	<b>29</b>
<b>General tips and advice for baking</b> .....	<b>31</b>
<b>Cooking table</b> .....	<b>32</b>
<b>Cleaning and maintenance</b> .....	<b>36</b>
Using the Aqua Clean program to clean the oven .....	37
Removing and cleaning the wire guides .....	38
Replacing the bulb .....	39
<b>Troubleshooting table</b> .....	<b>40</b>
Special warnings and fault reporting .....	40
<b>Disposal</b> .....	<b>41</b>

## **Safety precautions**

### **IMPORTANT SAFETY PRECAUTIONS – CAREFULLY READ THE INSTRUCTIONS AND SAVE THEM FOR FUTURE REFERENCE.**

Appliance must be connected to fixed wiring which has incorporated means of disconnection. Fixed wiring must be made in accordance with the wiring rules.

Means for disconnection must be incorporated in the fixed wiring in accordance with the wiring rules.

The appliance must not be installed behind a decorative door in order to avoid overheating.

If the supply cord is damaged, it must be replaced by the manufacturer, its service agent or similarly qualified persons in order to avoid a hazard (only for appliances supplied with connection cord).

This appliance can be used by children aged 8 years and above, and by persons with reduced physical, sensory or mental capabilities or lack of experience and knowledge, if they have been given supervision or instruction concerning the use of the appliance in a safe way, and if they understand the hazards involved. Children shall not play with the appliance. Cleaning and user maintenance shall not be done by children without supervision.

**WARNING:** Accessible parts may become hot during use. Young children should be kept away.

**WARNING:** The appliance and some of its accessible parts may become very hot during use. Care should be taken to avoid touching heating elements. Children less than 8 years of age shall be kept away unless continuously supervised.

The appliance is not intended to be controlled by external timers or separate remote control system.

Do not use harsh abrasive cleaners or sharp metal scrapers to clean the oven door glass/ the glass of hinged lids of the hob (as appropriate), since they can scratch the surface, which may result in shattering of the glass.

Do not use steam cleaners or high-pressure cleaners to clean the appliance as this may result in an electric shock.

**WARNING:** Before replacing the light bulb, make sure the appliance has been disconnected from the mains power, in order to prevent the hazard of an electric shock.

Never pour water directly on the bottom of the oven cavity. Temperature differences could result in damage to the enamel coating.

### **Safe use of the microwave oven**

**WARNING:** Due to the extremely high temperatures generated when the appliance is used in combination mode, it is recommended that children only use the oven under adult supervision.

**WARNING:** If the door or door seals are damaged, the oven must not be operated until it has been repaired by a competent person.

**WARNING:** It is extremely hazardous for anyone other than a competent person to carry out any service or repair operation that involves the removal of covers protecting against exposure to microwave energy.

**WARNING:** Liquids and other foods must not be heated in sealed containers since they are liable to explode.

The appliance is intended for use in households and similar environments, such as:

- staff pantries in stores and other working environments;
- family farms;
- accommodation units for guests at hotels, motels, and other accommodation or lodging establishments;
- bed and breakfast establishments.

Only use utensils suitable for use in microwave ovens.

When cooking with microwaves, do not use metal containers for food or beverages.

When heating food in plastic or paper containers, keep an eye on the oven, as such packaging may ignite.

Microwave heating of beverages can result in delayed eruptive boiling. Therefore, take care when handling the container with the heated beverage. To prevent this, place a non-metal object (e.g., a wooden, glass, or plastic spoon) into the container during the heating-up process.

To avoid burns, the contents of baby bottles and baby food jars should be shaken or stirred, and their temperature checked before feeding.

Eggs in their shell should not be heated in microwave ovens since they may explode even after microwave heating has ended.

If you observe smoke, switch off or unplug the appliance and keep the oven door closed to stifle any flames.

The microwave oven is intended for heating food and beverages. Drying food or clothing and heating of hot packs or pads, slippers, sponges, moist cloths etc. may result in injury, ignition, or fire.

The oven should be cleaned regularly, and any food deposits should be removed.

Failure to maintain the oven in a clean condition could lead to deterioration of the surface that could adversely affect the life of the appliance and possibly result in a hazardous situation.

If the appliance is integrated into a kitchen cupboard with a door, the cupboard door should be open while the appliance is in use.

## **Other important safety warnings**

The appliance is intended for household use. Do not use it for any other purpose, such as room heating, drying of pets or other animals, paper, fabrics, herbs etc. As this may lead to injury or fire hazard.

Appliance must be connected to fixed wiring which has incorporated means of disconnection. Fixed wiring must be made in accordance with the wiring rules.

We recommend that (due to appliance weight) at least two persons carry and install the appliance.

Do not lift the appliance by holding it by the door handle.

Oven door hinges may be damaged when under excessive load. Do not stand or sit on the open oven door, and do not lean against it. Also, do not place any heavy objects onto the oven door.

If the power cords of other appliances placed near this appliance get entangled in the oven door, they can be damaged, which in turn can result in a short circuit. Therefore, make sure the power cords of other appliances are always at a safe distance.

Make sure the vents are never covered or obstructed in any other way.

Do not line the oven cavity with aluminium foil, and do not place any baking trays or other cookware on the oven bottom. This would obstruct and reduce air circulation in the oven, slow down the baking process, and destroy the enamel coating.

We recommend you avoid opening the oven door during baking, as this increases power consumption and increases condensate accumulation.

At the end of the baking process, and during baking, be careful when opening the oven door, as there is danger of scalding.

To prevent limescale accumulation, leave the oven door open after baking or using the oven, to allow the oven cavity to cool down to room temperature.

Clean the oven when it has completely cooled down.

Eventual mismatches in colour shades between different appliances or components within a single design line may occur due to various factors, such as different angles under which the appliances are observed, different coloured backgrounds, materials, and room illumination.

Do not use the appliance if it is damaged. Unplug the appliance from the power mains and call an authorized service centre.

The oven can be safely used with or without baking pan guides.

Do not store items in the oven, which could cause danger when the oven is switched on.

**Heed** the minimum distance between the upper edge of the oven and the closest object above it.

The microwave oven is intended for heating food and beverages. Drying food or clothing and heating of hot packs or pads, slippers, sponges, moist cloths etc. may result in injury, ignition, or fire.

**Always use oven mitts** to remove dishes from the oven. Some pots, pans, or trays may absorb the heat from the food and thus become very hot.

Make sure to **only use the cookware** that is suitable for use in a microwave oven. Do not use steel cookware or cookware with golden or silver decorative edges or ornaments.

**Do not leave any accessories or utensils** in your oven when it is off. Do not switch on an empty oven to avoid damaging it.

**Do not use** porcelain, ceramic, or earthenware cookware if such materials are porous or if such cookware is not glazed on the inside. Once heated up, the moisture that would penetrate these pores could cause cracking. Only use cookware intended for use in a microwave oven.

**Always read** and observe the instructions for heating in a microwave oven, specified on the food packaging.

**Be careful** when heating alcohol-containing food, as a combustible mixture of alcohol and air may form inside the oven. Be careful when opening the door.

Use of metal cookware, forks, spoons, knives or staples or fasteners on frozen food packages is not recommended when **cooking or heating with microwaves** or a combination of microwaves and convection baking. After heating, stir the food or leave it to rest until the heat is evenly distributed.

Do not connect the appliance to power supply if an ELCB (earth-leakage circuit breaker) is installed in the power supply circuit.



**WARNING!**

**Carefully read the instructions for use before connecting the appliance. Repair or any warranty claim resulting from incorrect connection or use of the appliance shall not be covered by the warranty.**

# Appliance description



## INFORMATION!

Appliance functions and equipment depend on the model.

Basic equipment of your appliance includes wire guides, shallow baking tray, and a wire rack.

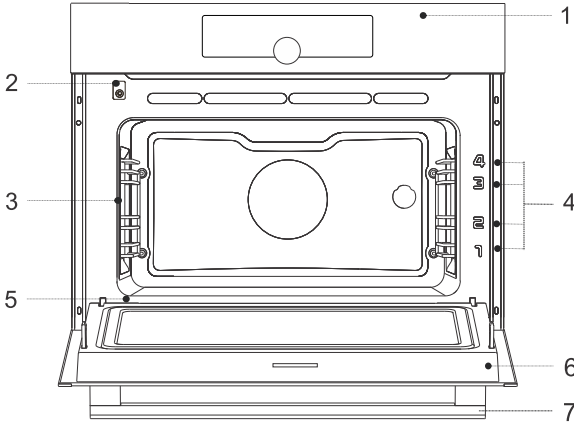

- |                           |                |
|---------------------------|----------------|
| 1 Control unit            | 5 Rating plate |
| 2 Door switch             | 6 Oven door    |
| 3 Lighting                | 7 Door handle  |
| 4 Guides – cooking levels |                |

## Rating plate – product information

A rating plate with basic information about the appliance is attached to the edge of the oven.

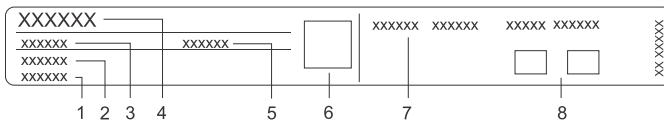

- |                 |                                    |
|-----------------|------------------------------------|
| 1 Serial number | 5 ID/code                          |
| 2 Model         | 6 QR code (depending on the model) |
| 3 Type          | 7 Technical information            |
| 4 Brand         | 8 Compliance labels/symbols        |

# Control unit

(depending on the model)

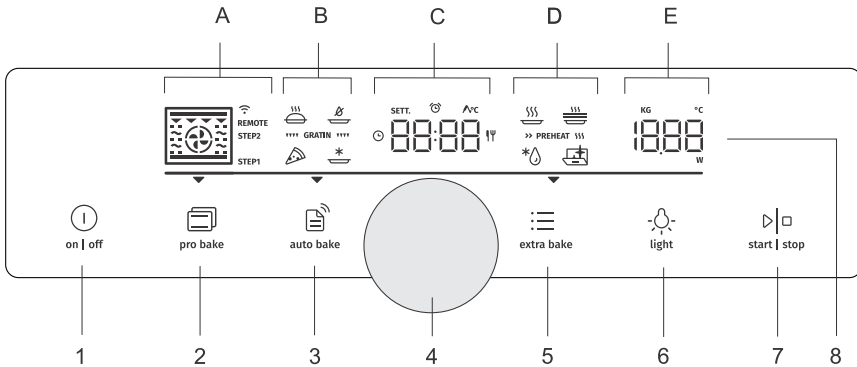

1. on | off key
2. (pro bake) professional mode key
3. (auto bake) automatic mode key
4. Settings selection and confirmation knob
  - rotate the knob to choose a setting
  - press the knob to confirm the setting
5. (extra bake) key for extra functions and general appliance settings
6. (light) key for switching the oven lighting on and off
7. start | stop key for starting or pausing, and confirming settings
8. Display
  - A. baking systems, step mode (STEP)
  - B. special baking systems, automatic programs, gratins
  - C. clock, timer functions, temperature probe, baking time
  - D. special programs, preheating
  - E. temperature, weight, power

## INFORMATION!

For better key response, touch the keys with a large area of your fingertip. Each time you press a key, this will be acknowledged by a short acoustic signal (if the function is available).

# Appliance equipment

## Control lights

**Oven light:** oven light is switched on when you open or close the oven door, when you switch on the oven, at the end of the baking process, and when you touch the oven light key on the control unit.

## Guides

- The guides allow cooking or baking on 4 rack levels.
- The height levels of guides into which the racks can be inserted shall be counted from bottom up.
- Guides 3 and 4 are intended for grilling.
- When inserting equipment, it should be correctly rotated.
- Always push the equipment all the way into the appliance.

## Wire guides

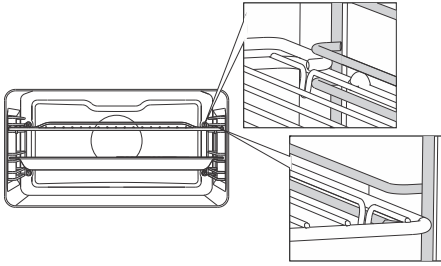

In case of wire guides, always insert the wire rack and the baking tray into the slot between the upper and lower part of each guide level.

## Oven door switch

If the oven door is opened during oven operation, the switch turns off the heaters, microwaves, and fan in the oven cavity. When the door is closed, the switch turns the appliance operation back on.

## Cooling fan

The appliance is fitted with a cooling fan that cools the housing, the door, and the appliance control unit. After the oven is switched off, the cooling fan continues to operate for a short while in order to cool down the oven.

## Oven equipment and accessories



### WARNING!

Never use the wire rack, the shallow baking tray or the deep baking tray or any other metal part or accessory when operating a system with microwaves.

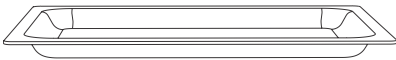

**GLASS BAKING DISH** is intended for cooking with all oven systems and for cooking with microwaves. It can also be used as a serving tray.



The **WIRE RACK** is used for grilling/broiling or as support for a pan, baking tray or baking dish with the food you are baking.



### INFORMATION!

There is a safety latch on the wire rack. Therefore, the wire rack has to be lifted slightly at the front when pulling it out from the oven.

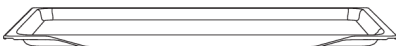

**SHALLOW BAKING TRAY** is used for flat and small pastry. It can also be used as a drip tray.



**WARNING!**

The shallow baking tray may deform as it heats up in the oven. Once it cools down, it returns to the initial shape. Such deformation does not affect its function.

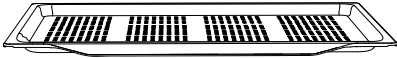

The **SHALLOW PERFORATED BAKING TRAY** is used for cooking with systems that feature steam injection and for air frying. The perforation improves airflow around the food for a crispier crust.

When cooking food with high liquid content (water, fat), place the shallow baking tray or all-purpose deep baking tray one rack lower to serve as drip tray.



**WARNING!**

The appliance and some of the accessible parts tend to heat up during cooking.

# Before first use

- Remove oven accessories and any packaging (cardboard, polystyrene foam) from the oven.
- Wipe the oven accessories and interior with a damp cloth. Do not use abrasive or aggressive cloths or cleaners.
- Heat an empty oven for approximately one hour with the top and bottom heater system at a temperature of 250 °C. The characteristic "new oven scent" will be released; therefore, ventilate the room thoroughly during this process.

# Microwave function

Microwaves are used for **cooking, roasting, and defrosting of food**. They allow quick and efficient cooking without changing the colour or shape of the food.

Microwaves are a type of electromagnetic radiation. Such radiation is commonly found in our environment in the form of radio-electric waves, light or infrared rays. Microwave frequency is in the 2,450 MHz range.

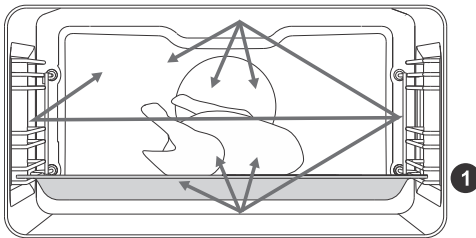

Following are their characteristics:

- microwaves are reflected by metals,
- microwaves travel through other materials,
- microwaves are absorbed by water, fat, and sugar molecules.

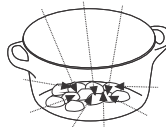
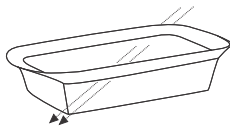
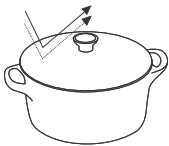

When food is exposed to microwaves, the molecules begin to move rapidly, thereby generating heat. The microwaves penetrate approximately 2.5 cm deep into the food. If the food is thicker, the core of the food will be cooked by conduction, as in conventional cooking.



## WARNING!

**Never use or activate a microwave system if the oven is empty.**

# Switching on for the first time

After connecting your appliance or after an extended power outage, 12:00 will flash on the display.

First, choose and confirm the following basic settings.



## INFORMATION!

Change them by rotating the KNOB. To confirm the desired setting, press the KNOB or touch the **start | stop** key.

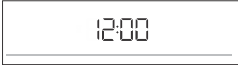

### 1. CLOCK SETTING

Set the clock/time of day. First, set and confirm the minutes; then set and confirm the hours.



### INFORMATION!

To set or adjust the clock later on, see chapter Extra functions.



### 2. ACOUSTIC SIGNAL VOLUME

Medium volume is the default setting. The sign **VoL** and the currently set value for the acoustic signal volume will appear on the display unit. Rotate the KNOB to increase or decrease the key volume.



### 3. DISPLAY DIMMER

Medium light intensity is the default setting. The sign **brht** and the currently set value for the display light intensity will appear on the display unit. Rotate the KNOB to increase or decrease lighting intensity.

After you confirm the selected settings, the clock will appear on the display unit. The appliance is in standby mode.

# Choosing the settings

The interface allows choosing several operating modes:

- Professional mode (pro bake)
- Automatic mode (auto bake)
- Extra functions (extra bake)
- Step program (STEP) in the professional mode (pro bake)
- Automatic programs in automatic mode (auto bake)

## INFORMATION!

- Rotate the KNOB to scroll through the settings.
  - First, confirm the selected setting by pressing the KNOB; then, change the setting.
  - Confirm each setting by pressing the KNOB.
  - A line and an arrow indicate the location of the parameter that you are looking to set.
  - Touch the **start | stop** key to start the program.
  - Operation of the **on | off** key:
    - brief touch: switch the oven on or off, stop the baking process or function.
    - long touch: the oven switches to low power consumption (power saving) mode.
- No key or KNOB are active, except for the on | off key. To switch on the oven, long-touch this key.



## pro bake **PROFESSIONAL MODE (pro bake)**

This function allows setting the baking parameters – baking system, temperature, fast preheating, and baking time – freely, at the user's discretion.

Touch the **pro bake** key and set the following:

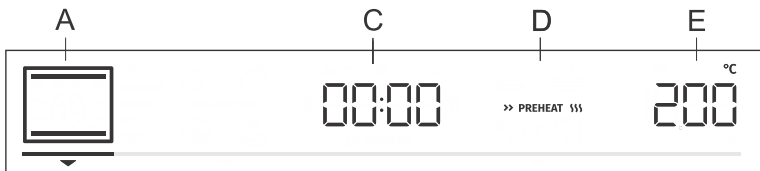

- A baking system
- C program duration
- D fast preheating
- E temperature/power (for systems with microwaves)

## INFORMATION!

In combined systems with microwaves, set the temperature first. Confirm your selection by pressing on the KNOB; then, set the microwave power.

Additionally, the following can be set:

- timer functions (see chapter Timer functions)
- step baking mode (STEP) (see chapter Step program)
- gratin (GRATIN) (see chapter Starting the cooking process)

## Fast preheat

Use the fast preheating function if you wish to heat the oven to the desired temperature as quickly as possible.

To activate fast preheating, rotate the KNOB to the setting >> PREHEAT ∞∞∞ (see image, label D). Confirm the selection. Rotate the KNOB to select the fully lit sign and confirm it. The function is now activated. When the selected temperature is reached, the preheating process stops and an acoustic signal is emitted. **door** will appear on the display unit. Open the door and insert the food. The program will automatically continue baking with selected settings.



### INFORMATION!

When the fast preheat function is activated, delayed start function cannot be used.

## CHOOSING THE COOKING SYSTEM













### INFORMATION!

Appliance functions and equipment depend on the model.

Symbol	Use
	<b>HOT AIR</b> Hot air allows better flow of hot air around the food. This way, it dries out the surface and creates a thicker crust. Use this system to cook meat, pastry and vegetables, and to dry food on a single rack or multiple racks simultaneously.
	<b>PIZZA SYSTEM</b> This system is optimal for baking homemade pizza and pastry with higher water content. Use it to bake on a single rack, when you want the food to be done faster and to be crunchy.
	<b>AIR FRY (INTENSIVE BAKING)</b> This cooking method results in a crunchy crust without added fat. This is a healthy version of fast-food frying, resulting in lower calorie content. Suitable for smaller cuts of meat, fish, vegetables, and frozen products ready for frying (French fries, chicken nuggets).
	<b>GRILL WITH HOT AIR</b> Hot air allows better flow of hot air around the food. This will dry out the surface. In combination with the grill heater/broiler, this will also result in a more intensive colour. For faster baking of meat and vegetables.
	<b>TURBO BAKE</b> For dishes where even crispiness from all sides is desirable. The system is also suitable as the first step in the step baking mode, as it allows quick browning of the surface in the first stage and slow baking in the second stage. The meat will be juicy with a nicely browned crust.
	<b>LARGE GRILL</b> Use this system to grill large amounts of flat-shaped food like toast, open sandwiches, grill sausages, steaks, fish, skewers etc., as well as for cooking au gratin and for browning the crust. The heaters mounted on the top of the oven cavity evenly heat the entire surface. Maximum allowed temperature: 240 °C
	<b>TOP AND BOTTOM HEATER</b> Use this system for conventional baking on a single rack, making soufflés, and baking at low temperatures (slow cooking).

Table continued from last page

Symbol	Use
	<b>GENTLE BAKING</b> For gentle and controlled slow cooking of delicate food (soft cuts of meat) and baking pastry with a crunchy bottom.
	<b>TOP AND BOTTOM HEATER WITH FAN</b> For even baking of food on a single rack, and for making soufflés.
	<b>LARGE GRILL WITH FAN</b> For roasting poultry and larger cuts of meat under a broiler.
	<b>LARGE GRILL AND BOTTOM HEATER</b> For faster baking on a single rack and for crisply browning the top of your pastry.
	<b>GRILL WITH BOTTOM HEATER AND FAN</b> For optimum baking of yeast-leavened dough, all types of bread, and for preservation.
	<b>MICROWAVES</b> These are used for fast reheating, defrosting, and cooking of food.
	<b>HOT AIR AND MICROWAVES</b> In this system, the flow of hot air around the food is improved to dry out the surface and create a thicker crust. Microwaves support and speed up the cooking process. Intended for faster cooking or roasting of meat, pastry, and vegetables.
	<b>LARGE GRILL WITH FAN AND MICROWAVES</b> For faster roasting of poultry, fish, and larger cuts of meat under a broiler. Microwaves support and speed up the cooking process.
	<b>CONVENTIONAL COOKING WITH FAN AND MICROWAVES</b> For faster cooking of dishes au gratin. Microwaves support and speed up the cooking process.
	<b>AIR FRY (INTENSIVE BAKING) WITH MICROWAVES</b> This cooking method results in a crunchy crust, without added fat. This is a healthy version of fast-food frying, with fewer calories in the cooked food. Intended for smaller cuts of meat, fish, and vegetables. Microwaves support and speed up the cooking process.

 **INFORMATION!**

In these systems, except for system with MICROWAVES, it is possible to use the gratin function (see chapter "Starting the cooking process").

## Microwave power level

Power	Use
1000 W	Quickly reheating beverages, water and dishes containing a large volume of liquid.
750 W	Cooking fresh or frozen vegetables.
600 W	Melting chocolate. Cooking meat and seafood. Cooking side dishes.
360 W	Reheating and cooking of delicate egg-based dishes.
180 W	Defrosting other food, softening butter, softening ice cream.
90 W	Defrosting cream pastry, fruit, vegetables, and ground/minced meat.

Touch the **start | stop** key to start the cooking process. Selected settings will appear on display unit.

## TIMER FUNCTIONS

Rotate the KNOB to select the timer functions.

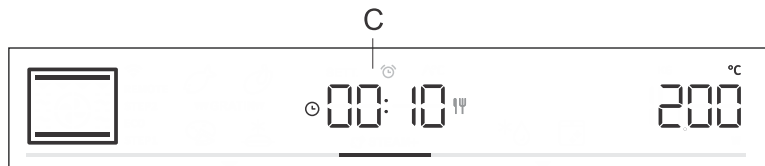

### Timed cooking

In this mode, you can specify the duration of oven operation (cooking time).

The cooking duration symbol  will appear on the display unit. Rotate the KNOB to set the desired cooking time. Confirm the setting by pressing on the KNOB.

Touch the **start | stop** key to start baking.



### Setting the delayed start



#### INFORMATION!

Delayed start is not possible when the preheating function is activated.



Use this function when you wish to start cooking the food in the oven after a certain period of time. Place the food into the oven, then set the system and temperature. Then, set the program duration and the time when you wish your food done.

Example:

Current time: 12:00 (noon)

Cooking time: 2 hours

End of cooking: at 18:00 (6 p.m.)

The cooking duration symbol  will appear on the display unit. Choose the setting and confirm it by pressing the KNOB (in our case, 2:00). Press the KNOB again and rotate it to select the symbol . Confirm and set the time when you wish your food to be done (in our case, this is 18:00, or 6 p.m.). Desired cooking end time will appear on the display unit (18:00). Confirm the setting by pressing on the KNOB.

Touch the **start | stop** key to start baking.

While waiting to be activated, the oven switches to a partial stand-by (the display unit goes dark). The oven will switch on with the selected settings automatically (in our case at 16:00, or 4 p.m.). The oven will switch off at the set time (in our case, this is 18:00, or 6 p.m.).



#### INFORMATION!

Cooking end time and the clock will alternate on the display unit.

After the set time expires, the oven will automatically stop operating. Sign **End** and **00.00** will alternate on the display unit. An acoustic signal will be emitted, which can be turned off by touching any key. After one minute, the acoustic signal will be switched off automatically.



**WARNING!**

**This function is not suitable for food requiring fast preheating.**

**Perishable food should not be kept in the oven for a long time. Before using this mode, check whether the clock on the appliance is accurately set.**



**Minute minder setting**

The minute minder can be used independently of oven operation. The longest possible setting is 24 hours. During the last minute, the minute minder is displayed in seconds.

Rotate the KNOB to select the  symbol and confirm your setting. Rotate the KNOB and set the minute minder duration. Confirm the setting by pressing on the KNOB.



**INFORMATION!**

The select timer function can be reset to 00:00 by long-pressing the KNOB.



**INFORMATION!**

The most recently used timer function values can be stored and offered as preset values the next time you use the timer. As a factory setting, this function is off, but it can be activated (see chapter Selecting extra functions, Adaptive function).

## STEP PROGRAM

This function allows baking in two steps or stages (two consecutive baking steps are combined in a single cooking process).

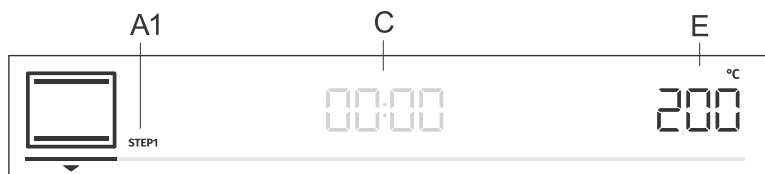

A1 first cooking step STEP1, (STEP2)

C program duration/end of program (see chapter Timer Functions)

E temperature

Step: STEP1

In the **pro bake** mode, set the baking system and temperature. You can also choose the fast preheating function. Then, set the baking duration for STEP1 (see chapter Timer Functions). Confirm the setting by pressing on the KNOB.

### **INFORMATION!**

In STEP1, you can set the delayed start; however, if you do so, you cannot activate fast preheating.

Step: STEP2

Press and hold the **pro bake** key. STEP2 (second cooking step) will appear on the display unit (the first one has already been set). Set the baking system, temperature, and duration. Confirm the setting by pressing on the KNOB.

If you wish, you can also modify STEP1 or STEP2 before starting them.

Touch the **pro bake** key and select STEP1. Now you can change the settings. Then, do the same for STEP2.

To delete the stem mode, press and hold the **pro bake** key.

Touch the **start | stop** key to start baking. The oven first starts to operate with the settings selected for STEP1. When the STEP1 is done, STEP2 is activated.



auto bake

## AUTOMATIC MODE (auto bake)

In this mode, you may choose between special baking systems or automatic programs (preset programs for particular types of food).

### Special baking systems

Touch the **auto bake** key and set the following:

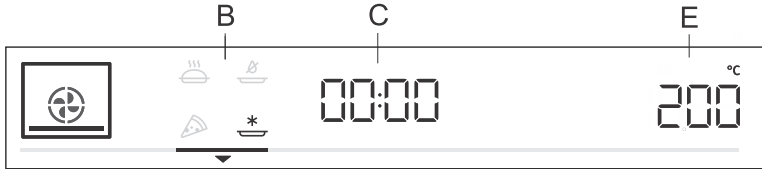





B special baking systems

C program duration (see chapter "Timer Functions")

E temperature/power

Rotate the KNOB and choose your settings. Preset values will be displayed: You can change the temperature and program duration.

Symbol	Use
	<b>BAKING FROZEN FOOD</b> <sup>1)</sup> This method allows baking frozen food in a shorter period of time without pre-heating. Optimum for pre-baked frozen products (bakery products, croissants, lasagne, French fries, chicken nuggets), meat and vegetables.
	<b>PIZZA SYSTEM</b> <sup>1)</sup> This system is optimal for baking homemade pizza and pastry with higher water content. Use it to bake on a single rack, when you want the food to be done faster and to be crunchy.
	<b>SLOW BAKING</b> <sup>2)</sup> For gentle, slow and even cooking of meat, fish and pastry on a single rack. This cooking method will leave the meat with a higher water content, making it juicier and more tender, while pastry will be evenly browned/baked. This system is used in the temperature range between 140 °C and 220 °C.
	<b>AIR FRY</b> <sup>1)</sup> This cooking method results in a crunchy crust without added fat. This is a healthy version of fast-food frying, with fewer calories in the cooked food. Suitable for smaller cuts of meat, fish, vegetables, and frozen products ready for frying (French fries, chicken nuggets).

<sup>1)</sup> In these systems, it is possible to use the gratin function (see chapter Starting the cooking process).

<sup>2)</sup> This function is used for determining the energy efficiency class pursuant to the EN 60350-1 standard.

### Fast preheat

Cooking procedures for some dishes in the auto bake mode also include the fast preheating function. The sign will be fully lit. When the selected temperature is reached, the preheating process stops and an acoustic signal is emitted. **door** will appear on the display unit. Open the door and insert the food. The program will automatically continue baking with selected settings.

**INFORMATION!**

When the fast preheat function is activated, delayed start function cannot be used.

**Automatic programs**

In the automatic mode (auto bake), you may choose between numerous automatic programs (the appliance will recommend the optimum cooking method, temperature, and cooking duration depending on the type of food specified).

**Press and hold** the (auto bake) key to display the automatic programs on the display unit (see table). Where possible, you can also set the weight of the food.

Confirm your setting by pressing the KNOB. Touch the **start | stop** key to start baking. Preset values will appear on the display unit.

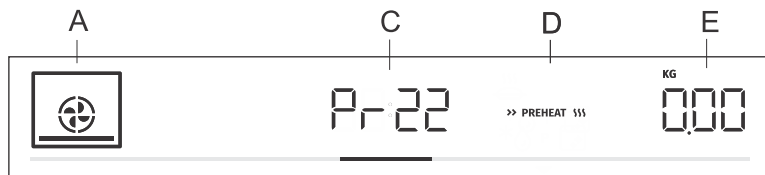

A baking system

C automatic program indication/program duration

D fast preheating

E selected amount

Indication	Program name	Equipment	Level	Preheating	Turning
Pr01	<b>piped cookies</b>	shallow baking tray	2	yes	no
Pr02	<b>cupcakes</b>	shallow baking tray	2	yes	no
Pr03	<b>sponge cake</b>	baking pan/dish on wire rack	1	yes	no
Pr04	<b>yeast-leavened small pastry</b>	shallow baking tray	2	yes	no
Pr05	<b>puff pastry</b>	shallow baking tray	2	yes	no
Pr06	<b>apple pie</b>	baking pan/dish on wire rack	2	no	no
Pr07	<b>apple strudel</b>	shallow baking tray	2	no	no
Pr08	<b>chocolate soufflé</b>	baking pan/dish on wire rack	2	yes	no
Pr09	<b>rising and proofing</b>	shallow baking tray	1	no	no
Pr10	<b>bread</b>	shallow baking tray	1	no	no
Pr11	<b>pork roast</b>	small baking dish on wire rack	1	no	no
Pr12	<b>potatoes au gratin</b>	glass baking dish	1	no	no
Pr13	<b>poultry – whole</b>	wire rack with a drip tray	2	no	after 2/3 of cooking time

Table continued from last page

Indication	Program name	Equipment	Level	Preheating	Turning
Pr14	poultry – smaller pieces	wire rack with a drip tray	2	no	after 2/3 of cooking time
Pr15	meat loaf	baking pan/dish on wire rack	1	no	no
Pr16	oven-baked beef steak	wire rack with a drip tray	3	no	after 2/3 of cooking time
Pr17	meat – slow cooking	small baking dish on wire rack	1	yes	no
Pr18	baked/grilled fish	wire rack with a drip tray	3	no	after 2/3 of cooking time
Pr19	baked potatoes – wedges	all-purpose deep baking tray	2	no	no
Pr20	popcorn	glass baking dish	1	no	no
Pr21	lasagne	baking pan/dish on wire rack	1	no	no
Pr22	homemade pizza	shallow baking tray	1	yes	no



#### INFORMATION!

Gratin function can be used with some automatic programs, except for Pr20 (see chapter "Starting the Cooking Process").



extra bake

## CHOOSING EXTRA FUNCTIONS (extra bake)

Touch the **extra bake** key to display extra functions with their respective preset values on the display unit.

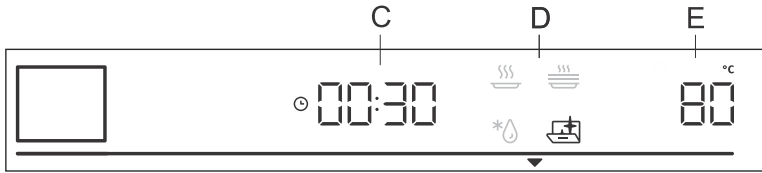

- C cooking duration
- D program
- E preset temperature

Rotate the KNOB and select the program. Preset values will be displayed: Some programs allow setting the temperature and cooking time.



### INFORMATION!

Rotate the KNOB to scroll through the programs. Confirm each setting by pressing the KNOB.



#### Aqua clean

This program allows easy removal of stains from the oven (see chapter Cleaning and Maintenance.)



#### Defrosting

Use this function to slowly defrost frozen food (cakes, pastry, bread, rolls, and deep-frozen fruit). Preset program values may be changed (temperature, cooking duration).

Halfway through the defrost time, the pieces should be turned over, stirred and separated if they were frozen together.



#### Reheating

This is used to keep warm the food that has already been cooked. You may set the temperature and reheating start and end time.



#### Plate warming

Use this function to reheat your dinnerware (plates, cups) before serving food in it to keep the food warm longer. You may set the temperature and reheating start and end time.

## Child lock

To activate the child lock, press and hold (for 5 seconds) the light key . **Loc** will appear on the display unit. When you long-press the light key again, the child lock is deactivated.

- If the lock is activated with no timer function engaged (only clock is displayed), then the oven will not operate.

- If the child lock is activated after a timer function has been set, then the oven will operate normally; however, it will not be possible to change the settings.
- When the child lock is activated, cooking or baking systems (modes) or additional functions cannot be changed. The cooking/baking/roasting process can only be stopped or switched off.
- Child lock will remain active after the oven is switched off. To select a new system, the child lock must first be deactivated.

# Starting the cooking process



Start the cooking process by pressing the **start | stop** key. Until the set temperature is reached for the first time, the current and the set temperature will alternate on the display unit. The temperature symbol flashes at first. When the desired temperature is reached, it goes off.



## INFORMATION!

If no timer function is selected, cooking time will appear on the display unit. A short acoustic signal is emitted when the oven reaches the selected temperature.

\*\*\* GRATIN \*\*\*

### Extra gratin

You may only activate this function 10 minutes after the start of the cooking process (the symbol **\*\*\* GRATIN \*\*\*** will appear on the display unit).

Press the KNOB to open settings. Rotate the KNOB to the sign **\*\*\* GRATIN \*\*\*** and confirm your selection. Rotate the KNOB again and select the fully lit sign. Confirm your selection. The function is now activated. Cooking time of 10 minutes (10:00) will appear on the display unit.

To change the duration, press on the KNOB twice and rotate it to adjust the time (max. 30 min). Confirm your selection.

The function is used in the last stage of the cooking process when you add sauce/wet rub or dry rub onto the food, or when you wish to additionally brown the crust. A golden-brown crust will form on the dish during the gratin process, which protects the food from drying out, while also imparting a more pleasant appearance and better flavour.



## INFORMATION!

The function can also be switched off while it is in progress. Rotate the KNOB to setting **\*\*\* GRATIN \*\*\***. Choose the dimmed sign and confirm it by pressing on the KNOB.

# End of cooking by touching

Touch the **start | stop** key to stop the operation. **End** appears on display unit and an acoustic signal is emitted. After three minutes, the clock will appear on the display unit.



## INFORMATION!

After the operation is completed, all timer settings are also stopped and deleted, except for the minute minder. Time of day (clock) will be displayed. The cooling fan will continue to operate for a while.

After the use of the oven, some water may be left in the condensate channel (underneath the door). Wipe the channel with a sponge or a cloth.

# General settings

Press and hold the **extra bake** key. **SEtt** will appear on the display unit for a few seconds. Then, the general settings menu will appear.



## INFORMATION!

Rotate the KNOB to scroll through the settings. Confirm each setting by pressing the KNOB or the **start | stop** key.



### Clock display

Rotate the KNOB to set the clock. **CLoc** will appear on the display unit. After confirming, you can choose between the 12h and 24h clock display. Confirm, then set the clock/time of day. First, set the minutes. Confirm, and then set the hours and confirm again.



### Acoustic signal volume

Choose between three acoustic signal volume levels. Rotate the KNOB to choose the **VoL** setting. Confirm the setting and set the volume. There are four available volume levels (zero bars – OFF, one, two or three bars).



### Display illumination

Choose between three levels of display light intensity. Rotate the KNOB to select the **brht** setting. Confirm your selection and choose lower or higher intensity. There are three available illumination levels (one, two or three bars).



### Display unit – night mode

This function will automatically dim the display (switch from high to low display illumination level) during night time (8:00 p.m. to 6:00 a.m.). Choose the **nGht** setting. Rotate the KNOB to switch On or OFF.



### Standby

This function switches the clock display on or off. Select the **hi dE** setting. Rotate the KNOB to switch On or OFF.



### Adaptive function

The function allows adjusting the set cooking temperature and the cooking time. As a factory default, this function is deactivated, but you can activate it.

When the function is activated, the most recent cooking time is displayed. Settings for the most recent cooking session lasting at least 1 minute are taken into account.

**AdPt** will appear on the display unit. To deactivate the function, rotate the KNOB to position OFF. Follow the same procedure to activate the function. Select "On" on the display unit.



### Automatic fast preheating

This function allows automatic addition of fast preheating to the baking systems that allow it.

Rotate the KNOB to select the **Auto** setting. Choose On or OFF.



### Sabbath

The Sabbath function allows keeping the food warm in the oven without having to switch the oven on or off.

Rotate the KNOB to select **SAbb**. Choose On or OFF.

Set the duration (between 24 and 72 hours) and temperature. Confirm each setting by pressing the KNOB.

If you wish the oven light to be on all the time, switch it on by touching the  symbol.

Touch the **start | stop** key to start the countdown. **SAbb** will appear on the display unit.

All sounds and operation will be deactivated, except for the **on | off** key.

### INFORMATION!

In case of a power outage, the Sabbath mode will be deactivated and the oven will return to the initial state.



### Factory settings

This function allows resetting the appliance to factory settings. **FAct** will appear on the display unit. Rotate the KNOB to select rES. Hold the **start | stop** until the end of animation to confirm.



### WARNING!

After a power outage or after the appliance is switched off, additional function settings will remain stored for no more than a few minutes. Then, all settings, except for the acoustic signal volume and display dimmer will be reset to factory defaults.

# General tips and advice for baking

- Remove all unnecessary equipment from the oven during baking
- Use equipment made of heat-resistant non-reflective materials (supplied baking trays and dishes, enamel-coated cookware, tempered glass cookware). Bright-coloured materials (stainless steel or aluminium) materials reflect heat. As a result, thermal processing of food in them is less effective.
- Always insert the baking sheets and trays to the end of the guides. When baking on the wire rack, place the baking dishes or trays in the middle of the rack.
- For optimum food preparation, we recommend observing the guidelines specified in the cooking table. Choose the lower specified temperature and the shortest specified cooking time. When this time expires, check the results and then adjust the settings as necessary.
- Unless it is absolutely necessary, do not open the oven door during baking.
- Do not place the baking trays directly onto the oven cavity bottom.
- Do not use the all-purpose deep baking tray on the 1st guide level while the appliance is operating.
- Do not cover the oven cavity bottom or the wire rack with aluminium foil.
- With longer cooking programs, you can switch off the oven approximately 10 minutes before the end of cooking time to make use of the accumulated heat.
- Always place the baking dishes onto the wire rack.
- When baking on several levels at the same time, insert the all-purpose deep baking tray into the lower level.
- When cooking according to recipes from older cookbooks, use the bottom and top heater system (as in conventional ovens) and set the temperature 10 °C lower than specified in the recipe.
- If you are using parchment paper, make sure it is resistant to high-temperatures. Always trim it accordingly. Parchment paper prevents the food from sticking to the baking tray and makes it easier to remove the food from the baking tray.
- When cooking larger cuts of meat or pastry with higher water content, a lot of steam will be generated inside the oven, which in turn may condense on the oven door. This is a normal phenomenon which will not affect the operation of the appliance. After the cooking process, wipe the door and the door glass dry.
- When baking directly on the wire rack, insert the all-purpose deep tray one level lower to serve as a drip tray.

**Fast preheating of the oven:** Only preheat the oven if required by the recipe of in the tables in these instructions for use. If you are using the fast preheating function, do not insert the food into the oven until the oven is fully heated. Temperature has a substantial effect on the final result. Fast preheating is recommended for delicate cuts of meat (sirloin), and for yeast-leavened and sponge dough that require a shorter baking time. Heating an empty oven consumes a lot of energy. Therefore, if possible, we recommend cooking several dishes in succession, or making several dishes simultaneously.

**GentleBake:** Allows slow and controlled cooking at a low temperature. The meat juices are distributed evenly, and the meat remains juicy and tender. The GentleBake slow cooking method is suitable for delicate boneless meat cuts. Before slow cooking, sear the meat thoroughly from all sides in a frying pan.

## **Use of microwaves:**

Use suitable cookware (glass, ceramic etc.).

Use cookware with a lid for cooking vegetables. Add 1 tablespoon of water per 100 g of food.

Turn or stir the food during the defrosting process.

# Cooking table

NOTE: Dishes requiring a fully pre-heated oven are indicated with a single asterisk \* in the table. Dishes for which a 5-minute pre-heating cycle suffices are indicated with two asterisks \*\*. In this case, do not use the rapid preheat mode.

























Dish			 °C/W	 min
<b>PASTRY AND BAKERY PRODUCTS</b>				
<b>pastry/cakes in moulds</b>				
sponge cake	1		160-170 *	20-35
pie with filling	1		170-180	60-80
marble cake	1		160-170	30-40
cake with leavened dough, Gugelhupf (Bundt cake, pound cake)	1		170-180	50-60
open pie, tart	2		170-190	40-50
brownies	2		170-180 *	25-35
<b>pastry on baking trays and dishes</b>				
strudel	2		170-180	55-65
strudel, frozen	2		200-210	45-60
sponge roll	2		170-180	15-25
buchteln	1		180-190	30-40
<b>biscuits, cookies</b>				
cupcakes	2		160-170 *	20-35
cupcakes, 2 levels	2, 3		140-150 *	25-45
yeast-leavened small pastry	2		190-200	20-30
yeast-leavened small pastry, 2 levels	2, 3		170-180	20-30
puff pastry	2		170-180	20-30
puff pastry, 2 levels	2, 3		160-170	20-30
<b>cookies/biscuits</b>				
pipéd cookies	2		140-150 *	25-40
pipéd cookies, 2 levels	2, 3		140-150 *	30-45
cookies/biscuits	2		160-170 *	25-35
biscuits, 2 levels	2, 3		160-170 *	15-25
meringue	2		80	120-140

Table continued from last page





























Dish			 °C/w	 min
meringue, 2 levels	2, 3		70	120-140
macarons	2		140	13-18
macarons, 2 levels	2, 3		140	15-20
<b>bread</b>				
rising and proofing	2		35-40	30
bread on a baking tray	1		190-200	50-60
bread in a tin	1		190-200	30-45
flatbread (focaccia)	2		210-220 *	25-35
fresh bread rolls (Semmel/morning rolls)	2		190-200 *	20-30
toasted bread	4		240 *	0.5-3
open sandwiches	3		240 *	2-5
<b>pizza and other dishes</b>				
homemade pizza	1		275 *	10-17
homemade pizza, 2 rack levels	2, 3		210-220 *	30-40
frozen pizza	2		210-230	10-20
frozen pizza, 2 levels	2, 3		200-220	15-25
savoury pie, quiche	1		190-210	50-60
burek	1		180-200	30-40
<b>MEAT</b>				
<b>beef and veal</b>				
beef roast (loin, rump), 1.5 kg	1		160-180	130-160
boiled beef, 1.5 kg	1		190-210	90-110
sirloin, medium done, 1 kg	2		170-190 *	40-60
beef roast, slow cooked	1		120-140 *	250-300
beef steaks, well done, thickness 4 cm	3		200-220	25-35
burgers, thickness 3 cm	3		240	20-35
veal roast, 1.5 kg	2		180-200	100-120
<b>pork</b>				
pork roast, rump, 1.5 kg	1		170-190	90-120

Table continued from last page

Dish				
pork roast, shoulder, 1.5 kg	1		180-200	140-170
pork loin, 400 g	1		80-100 *	80-100
pork roast, slow cooked	1		100-120 *	200-230
pork ribs, slow cooked	1		120-140 *	210-240
pork chops, thickness 3 cm	13		220-230	20-30
<b>poultry</b>				
poultry, 1.2–2.0 kg	1		200–210/360	45-60
poultry with stuffing, 1.5 kg	1		170-190	100-120
poultry, breast	2		190-210	50-60
chicken thighs	1		190–200/600	20-30
chicken wings	2		210-220	20-35
poultry, breast, slow cooked	2		100-120 *	60-90
<b>meat dishes</b>				
meat loaf, 1 kg	2		170-190	75-90
grill sausages, bratwurst	3		230 **	8-15
<b>FISH AND SEAFOOD</b>				
whole fish, 350 g	3		230–240/360	12-17
fish fillet, thickness 1 cm	3		220-230	8-12
fish steak, thickness 2cm	3		220-230	10-15
scallops	3		230 *	5-10
shrimps	3		230 *	3-10
<b>VEGETABLES</b>				
baked potatoes, wedges	3		210-220 *	35-45
baked potatoes, halved	2		200–210/360	30-40
stuffed potato (jacket potato)	3		190-200	30-40
French fries, home-made	2		210–220/360	25-35
mixed vegetables, wedges	3		190-200	30-40
stuffed vegetables	3		190-200	30-40
steamed vegetables	1		600-750	10-20
<b>CONVENTIONAL PRODUCTS – FROZEN</b>				

Table continued from last page

Dish				
French fries	3		200-210	25-35
french fries, 2 levels	2, 3		200-210	35-45
chicken medallions	2		210-220 *	15-20
fish fingers	2		210-220	15-25
lasagne, 400 g	2		200-210	30-40
diced vegetables	2		190-200	20-30
croissants	2		170-180	18-23
<b>BAKED PUDDINGS, SOUFFLÉS AND DISHES AU GRATIN</b>				
potato moussaka	1		200-210/360	35-45
lasagne	1		200-210/360	35-45
sweet baked pudding	1		750	15-25
sweet soufflé	2		180 *	15-20
dishes au gratin	2		170-190	30-45
stuffed tortillas, enchiladas	2		180-200	20-35
grilling cheese	3		240 **	6-9
<b>OTHER</b>				
popcorn	1		1000	3-4
preservation	2		180	30
sterilization	2		1000	2
cooking in a bain-marie (double boiler)	1		150-170 *	/
reheating	1		600	/
plate warming	2		75	15
defrosting	1		90-180	/

# Cleaning and maintenance



## WARNING!

Before cleaning, unplug the appliance from the power mains and wait for the appliance to cool down.

**Children should not clean the appliance or perform maintenance tasks without proper supervision.**

For easier cleaning, oven cavity and baking tray are coated with special enamel for a smooth and resistant surface.

Regularly clean the appliance and use warm water and hand dishwashing liquid to remove larger impurities and limescale. Use a clean soft cloth or sponge cloth.

**Appliance exterior:** use hot soapsuds and a soft cloth to remove impurities, then wipe the surfaces dry.

**Appliance interior:** for stubborn dirt and grime, use conventional oven cleaners. When using such cleaners, thoroughly wipe the appliance with a wet cloth to remove all cleaner residue.

**Accessories and guides:** clean with hot soapsuds and a damp cloth. For stubborn dirt and grime, we recommend prior soaking and use of a brush.

If the cleaning results are not satisfactory, repeat the cleaning process.



## INFORMATION!

Never use aggressive or abrasive cleaners and accessories (abrasive sponges and detergents, stain and rust removers, scrapers for glass ceramic plates).

Oven equipment is dishwasher-safe.

Food residue (fat, sugar, protein) can ignite during the use of the appliance. Therefore, remove larger chunks of dirt from the oven interior and accessories before each use.

**Appliance door** is attached to the appliance and may not be removed. Also, the door may not be disassembled or otherwise tampered with.

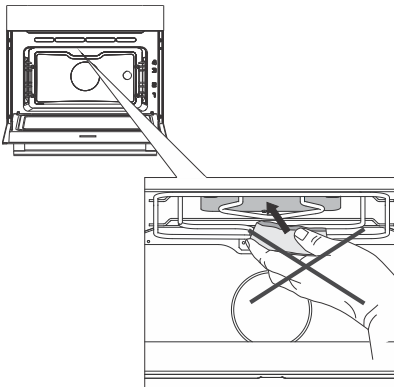

Never use aggressive cleaners, abrasive cleaners or sponges, stain and rust removers etc. on the oven cavity ceiling cover.

## Using the Aqua Clean program to clean the oven

This program makes it easier to remove any stains from inside the oven.

The function is the most effective if used regularly, after each use.

Before running the cleaning program, remove all large visible chunks of dirt and food residues from the oven cavity.

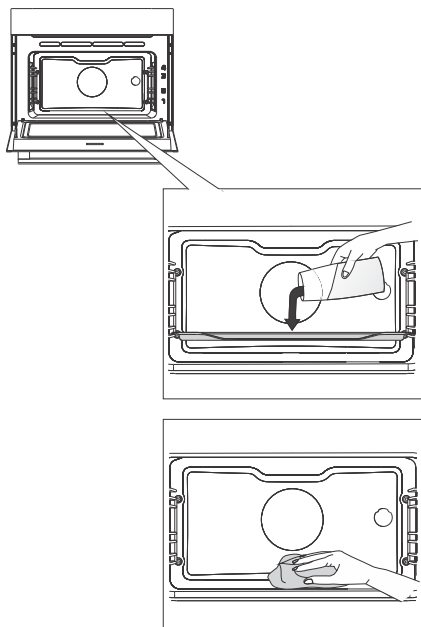

**1** Insert the glass baking dish into the first guide level and pour 1.5 dl of warm water into it.

**2** Touch the **extra bake** key to display extra functions on the display unit. Rotate the KNOB to the symbol . Preset values will appear on the display unit.

**3** The program will operate for 8 minutes. When the program is complete, **End** will appear on the display unit.

**4** When the program is completed, carefully remove the baking tray, using oven mitts (there can still be some water on the baking tray). Wipe down the stains with damp cloth and soapsuds. Thoroughly wipe the appliance with a wet cloth to remove all cleaner residue.

### INFORMATION!

If the cleaning process is not successful (in case of particularly stubborn dirt), repeat it.

### WARNING!

Use the Aqua Clean system when the oven has fully cooled down.

## Removing and cleaning the wire guides

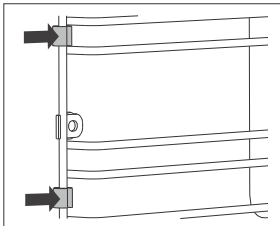
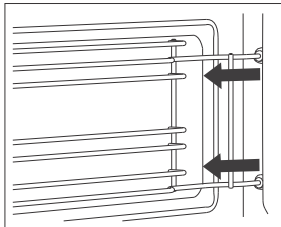
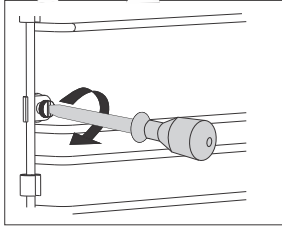
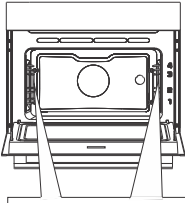

**1** Undo the screw. Use a screwdriver.

**2** Remove the guides from the holes in the back wall.



### **INFORMATION!**

Take care not to lose the spacers fitted on the wire guides. Replace the spacers after cleaning; otherwise, sparks may appear.



### **WARNING!**

After cleaning, re-tighten the screws on the guides with a screwdriver.

When replacing the wire guides, make sure you mount them on the same side they were installed on prior to removal.

# Replacing the bulb

The bulb is a consumable and therefore not covered by warranty. Before replacing the bulb, remove all accessories from the oven.

The oven is fitted with a halogen lamp.

This product contains a light source of energy efficiency class (G).

Halogen lamp: G9, 230 V, 25 W

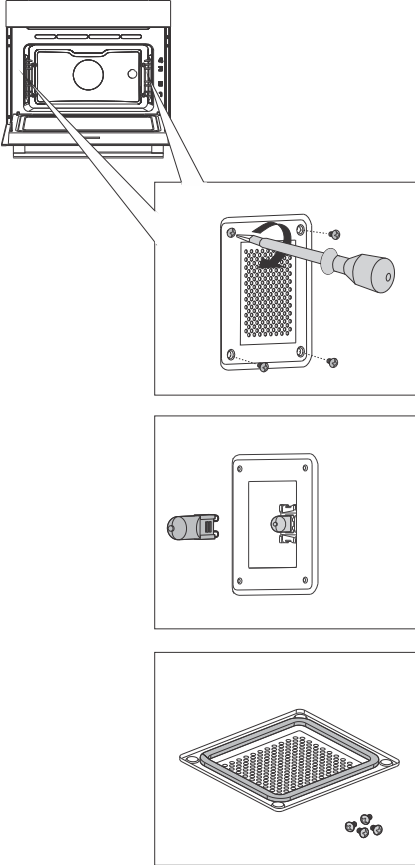

**1** Undo the four screws. Remove the cover and the glass.

**2** Remove the halogen light bulb and replace it with a new one.

## **INFORMATION!**

Use protection to avoid burns.

There is a gasket on the cover which should not be removed. The gasket should fit onto the oven cavity wall.



## **WARNING!**

**Only replace the light bulb when the appliance is disconnected from power supply.**

**Firmly re-tighten the screws on the cover using a screwdriver; otherwise, sparks may appear.**

# Troubleshooting table

## Special warnings and fault reporting

**During the warranty period, only a service center authorized by the manufacturer may carry out any repairs.**

Before making any repairs, make sure the appliance is disconnected from the power mains either by removing the fuse or by disconnecting the power plug from the wall outlet.

Any unauthorized repairs of the appliance may result in electric shock and short circuit hazard; therefore, do not perform them. Leave such work to an expert or a service technician.

In case of minor problems with appliance operation, check this manual to see if you can fix the problem yourself.

If the appliance is not operating properly or at all due to inappropriate operation or handling, a visit from a service technician shall not be free of charge, even during the warranty period.

Save the instructions for future reference and pass them on to any subsequent owners or users of the appliance.

Following is some advice on rectifying some common problems.

<b>Problem/error</b>	<b>Cause</b>
<b>The main fuse in your home trips often.</b>	Call a service technician.
<b>The oven lighting does not work.</b>	The process of changing the light bulb in the oven is described in the chapter Replacing the bulb.
<b>Control unit is not responding, the screen is frozen.</b>	Disconnect the appliance from the power mains for a few minutes (undo the fuse or switch off the main switch); then, reconnect the appliance and switch it on.
<b>Error code ErrX is displayed. In case of a double-digit error code, ErXX will be displayed.</b>	There is an error in the electronic module operation. Disconnect the appliance from the power mains for a few minutes. If the error is still indicated, call a service technician.
<b>Sparks appear in the oven</b>	Make sure all lamp covers are securely fastened and that all spacers are fitted on the wire guides. Make sure the guides in the oven are correctly placed.

If the problems persist despite observing the above advice, call an authorized service technician. Repair or any warranty claim resulting from incorrect connection or use of the appliance shall not be covered by the warranty. In this case, the user will cover the cost of repair.

# Disposal



Our product packaging is made of environmentally friendly materials that can be recycled, disposed of, or destroyed without any hazard to the environment. To this end, packaging materials are labelled appropriately.

**The symbol** on the product or its packaging indicates that the product should not be treated as normal household waste. Take the product to an authorized collection centre for waste electric and electronic equipment processing.

Correct **disposal** of the product will help prevent any negative effects on the environment and health of people, which could occur in case of incorrect product removal. For detailed information on removal and processing of the product, please contact the relevant municipal body in charge of waste management, your waste disposal service, or the store where you bought the product.

We reserve the right to any changes and errors in the instructions for use.

**gorenje**



876371-a13

